



Copyright

Fujitsu Limited has made every effort to ensure the accuracy and completeness of this document. However, as ongoing development efforts are continually improving the capabilities of our products, we cannot guarantee the accuracy of the contents of this document. We disclaim liability for errors, omissions, or future changes.

LifeBook is a trademark of Fujitsu Limited.

Microsoft, Windows, MS, MS-DOS, and Windows NT are registered trademarks of the Microsoft Corporation of the United States in the United States and other countries.

Intel is a registered trademark of the Intel Corporation of the United States.

Celeron is a trademark of the Intel Corporation of the United States.

ATI is registered trademark of ATI Technologies INC.

Macrovision :-

This product incorporates copyright protection technology that is protected by method claims of certain U.S. patents and other intellectual property rights owned by Macrovision Corporation and other rights owners. Use of this copyright protection technology must be authorized by Macrovision Corporation, and is intended for home and other limited viewing uses only unless otherwise authorized by Macrovision Corporation. Reverse engineering or disassembly is prohibited. Apparatus Claims of U.S. Patent Nos. 4,631,603, 4,577,216, 4,819,098 and 4,907,093 licensed for limited viewing uses only.

Dolby :-

Manufactured under license from Dolby Laboratories. "DOLBY", "PRO LOGIC," and the double-D symbol are trademarks of Dolby Laboratories. Copyrights 1992-1999 Dolby Laboratories, All rights reserved.

Phoenix is a registered trademark of Phoenix Technologies Corporation of the United States.

K56flex is a trademark of Rockwell International Corporation and Lucent Technologies Corporation.

Other product names are trademarks or registered trademarks of their respective companies.

Other products are copyrighted by their companies.

Copyright© 1981-2001 Microsoft Corporation, All rights reserved.

Copyright© 2001 Phoenix Technologies, Ltd., All rights reserved.

All other products are trademarks or registered trademarks of their respective companies.

Explanations of the adjustments for the track pad cursor control are taken in part from the ALPS GlidePoint Driver User's Guide, copyright by LCS/Telegraphics in 1996.

© Copyright 2001 Fujitsu Limited. All rights reserved. No part of this publication may be copied, reproduced, or translated, without the prior written consent of Fujitsu Limited. No part of this publication may be stored or transmitted in any electronic form without the written consent of Fujitsu Limited.



DECLARATION OF CONFORMITY according to FCC Part 15

This device complies with Part 15 of the FCC Rules. Operations are subject to the following two conditions:

(1) This device may not be allowed to cause harmful interference, (2) This device must accept any interference received, including interference that may cause undesired operation.

Website: www.fujitsu-pc-asia.com



IMPORTANT SAFETY INSTRUCTIONS

1. Read these instructions carefully. Save these instructions for future reference.
2. Follow all warnings and instructions marked on the product.
3. Unplug this product from the wall outlet before cleaning. Do not use liquid cleaners or aerosol cleaners. Use a damp cloth for cleaning.
4. Do not use this product near water.
5. Do not place this product on an unstable cart, stand, or table. The product may fall, causing serious damage to the product.
6. Slots and openings in the cabinet and the back or bottom are provided for ventilation; to ensure reliable operation of the product and to protect it from overheating, these openings must not be blocked or covered. The openings should never be blocked by placing the product on a bed, sofa, rug, or other similar surface. This product should never be placed near or over a radiator or heat register, or in a built-in installation unless proper ventilation is provided.
7. This product should be operated from the type of power indicated on the marking label. If you are not sure of the type of power available, consult your dealer or local power company.
8. This product is equipped with a 3-wire grounding-type plug, a plug having a third (grounding) pin. This will only plug into a grounding-type power outlet. This is a safety feature. If you are unable to insert the plug into the outlet, contact your electrician to replace your obsolete outlet. Do not defeat the purpose of the grounding-type plug.
9. Do not allow anything to rest on the power cord. Do not locate this product where persons will walk on the cord.
10. If an extension cord is used with this product, make sure that the total ampere rating of the equipment plugged into the extension cord does not exceed the extension cord ampere rating. Also, make sure that the total rating of all products plugged into the wall outlet does not exceed 15 amperes.
11. Never push objects of any kind into this product through cabinet slots as they may touch dangerous voltage points that could result in a fire or electric shock. Never spill liquid of any kind on the product.
12. Do not attempt to service this product yourself, as opening or removing covers may expose you to dangerous voltage points or other risks. Refer all servicing to qualified service personnel.
13. Unplug this product from the wall outlet and refer servicing to qualified service personnel under the following conditions:
 - a. When the power cord or plug is damaged or frayed.
 - b. If liquid has been spilled into the product.
 - c. If the product has been exposed to rain or water.
 - d. If the product does not operate normally when the operating instructions are followed. Adjust only those controls that are covered by the operating instructions since improper adjustment of other controls may result in damage and will often require extensive work by a qualified technician to restore the product to normal condition.
 - e. If the product has been dropped or the cabinet has been damaged.
 - f. If the product exhibits a distinct change in performance, indicating a need for service.
14. **CAUTION. When replacing the battery, be sure to install it with the polarities in the correct position. There is a danger of explosion if the battery is replaced with an incorrect type or is mistreated. Do not recharge, disassemble or dispose of in fire. Replace only with the same or equivalent type recommended by the manufacturer. Dispose of the used battery according to the manufacturer's instructions.**
15. Use only the proper type of power supply cord set (provided in your accessories box) for this unit. It should be a detachable type: UL listed/CSA certified, BS1363,ASTA,SS145 certified, rated 10A 250V minimum, VDE approved or its equivalent. Maximum length is 15 feet (4.6 meters).



AUSTRALIAN WARNINGS

WARNING

FOR SAFETY REASONS, ONLY CONNECT EQUIPMENT WITH A TELECOMMUNICATIONS COMPLIANCE LABEL. THIS INCLUDES CUSTOMER EQUIPMENT PREVIOUSLY LABELLED PERMITTED OR CERTIFIED.

Connection of Non Certified/Approved peripherals may result in the equipment operating outside the Australian EMI Standards.

Modems connected to the Australian telecommunications network must be operated in accordance with the Labelling Notice. This modem has been specifically configured to ensure compliance with the ACA Standards. Do not adjust your modem or software outside the values indicated below. To do so would result in your modem being operated in a non-compliant manner.

Call Attempts/Retries:

Applications software shall be configured so that no more than 3 attempts are made to establish a connection to a given number (Note: if the modem can detect service tones, up to 10 attempts can be made). If the call sequence is unsuccessful, there shall be a delay of at least 30 minutes before attempting to call the number again.

Failure to set the modem, and any application software used with the modem, to the values shown above will result in the modem being operated in a non-compliant manner. Consequently, this would be in violation of the Labelling Notice for this equipment, and the Telecommunications Act 1997 prescribes penalties for the connection of non-compliant equipment.



NEW ZEALAND WARNINGS

The grant of a Telepermit for any item of terminal equipment indicates only that Telecom has accepted that the item complies with minimum conditions for connection to its network. It indicates no endorsement of the product by Telecom, nor does it provide any sort of warranty. Above all, it provides no assurance that any item will work correctly in all respects with another item of Telepermitted equipment of a different make or model, nor does it imply that any product is compatible with all of Telecom's network services.

This equipment is not capable under all operating conditions of correct operation at the higher speeds for which it is designed. 56 KBPS connections are likely to be restricted to lower bit rates when connected to some PSTN implementations. Telecom will accept no responsibility should difficulties arise in such circumstances.

Immediately disconnect this equipment should it become physically damaged, and arrange for its disposal or repair.

This equipment shall not be used in any manner, which could constitute a nuisance to other Telecom customers.

This equipment shall not be set to make automatic calls to the Telecom "111" Emergency Service. This device is equipped with pulse dialling while the New Zealand standard is DTMF tone dialling. There is no guarantee that Telecom lines will always continue to support pulse dialling. It is strongly recommended that pulse dialling is not used.

Some parameters required for compliance with Telecom's Telepermit requirements are dependent on the equipment (PC) associated with this device. The associated equipment shall be set to operate within the following limits for compliance with Telecom's Specifications:

For repeat calls to the same number.

There shall be no more than 10 call attempts to the same number within any 30 minute period for any single manual call initiation, and

The equipment shall go on-hook for a period of not less than 30 seconds between the end of one attempt and the beginning of the next attempt.

For Automatic calls to different numbers.

The equipment shall go on-hook for a period of not less than 5 seconds between the end of one attempt and the beginning of the next attempt.

For Automatically answered Incoming Calls

Incoming calls shall be answered between 3 and 30 seconds from the start of the ringing.

For correct operation, the total of the RNs of all devices connected to a single line at anytime should not exceed 5. The RN of this Equipment is 0.5.

WARNING

Connection of Non Certified/Approved peripherals may result in the equipment operating outside the New Zealand EMI Standards.



Note: Modem setting in Windows 98 / Windows Me

The default modem setting in Windows 98 / Windows Me operating system is United States of America. If you are residing in Australia or New Zealand, please choose the appropriate country where you are located.

The Modem will only operate with Tone Dialing; Selection of Pulse dialing is not possible.

Please see below instruction for quick modem setup.

A. If you are located in Australia

1. Go to Control panel, select modem icon.
2. Choose Australia in “What country/region are you in now?”
3. Select Phone system as “Tone Dialing”
4. Close

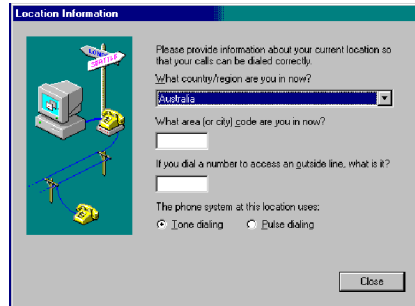

B. If you are located in New Zealand

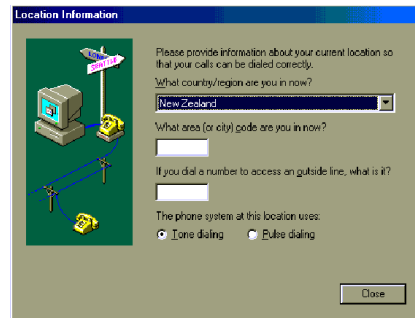

1. Go to Control panel, select modem icon.
2. Choose New Zealand in “What country/region are you in now?”
3. Select Phone system as “Tone Dialing”
4. Close





NOTATION IN THIS DOCUMENT

● Warnings

This manual uses a variety of icons as visual marks so that you can use this computer safely and correctly and avoid damage and danger to yourself and to others. These icons and their meanings are as follows. Please learn these icons before reading this manual. Learning these icons will be useful for understanding this manual.

Icon	Meaning
 WARNING	Incorrect handling ignoring this warning can cause a dangerous situation that could result in death or severe injury.
 CAUTION	Incorrect handling ignoring this warning can cause a dangerous situation that could result in moderate or minor injury or could result in equipment damage.

The symbols below are used together with the icons above to indicate what type of danger or damage is involved.

symbols	Meaning
	The symbol Δ indicates a warning or caution. The symbol Δ indicates the concrete nature of the warning. (The example on the left is a caution for electric shock.)
	The circle and slash indicates prohibited behavior. The symbol inside the circle indicates the concrete nature of the prohibition. (The example on the left indicates that disassembly is prohibited.)
	The ● indicates instructions that must be followed. The symbol inside indicates the concrete nature of those instructions. (The example on the left tells you to unplug the power plug from the socket.)

● Key notation and operation methods

Explanations of key operations do not show all the characters on the keyboard. Instead they indicate just the keys necessary to the explanation as follows.

Examples: **[Ctrl]** key, **[Enter]** key, **[→]** key

When multiple keys are to be pressed at the same time, this is indicated by connecting them with **[+]**.

Examples: **[Ctrl] + [F3]** keys; **[Shift] + [↑]** key

● Screen examples

The screens shown in this manual are examples. Please understand that the file names and screens you use may be different.



● **Notation in text**

Here is what symbols in text mean.

Symbol	Meaning
Critical Points	Critical Point Indicates a point necessary for correctly operating the hardware or software.
 Column	Column Gives the meaning and brief explanation of a term.
→	Indicates the page to see elsewhere in this manual.

● **Command input (key input)**

Within the text of this manual, command input (giving commands to the computer by pressing keys) is indicated as follows.

Example: `dir c:`



In the position indicated in the example above by the ↑, the space left between the characters indicates that a space needs to be left in the entry by pressing the space bar (the long key with nothing written on it at the center of the front of the keyboard). Commands are written in this manual as lowercase latin letters, but uppercase letters may be used.

● **Product names**

The following product names are abbreviated as follows in this manual.

“Microsoft® Windows® 2000 operating system” is written as “Windows 2000”.

“Microsoft® Millennium® Edition operating system” is written as “Windows Me”.

“Microsoft® Windows® 98 operating system” is written as “Windows 98”.

“Windows NT 4.0” and “Windows NT 3.51” are both written as Windows NT.

“LifeBook” is written as “this computer” or “the computer main unit”.



Configuration of this Manual

SECTION 1

This section explains basic operations and basic items for using this computer, including the names of the parts and their functions, flat point operation methods, floppy disk unit handling, and battery operation.

SECTION 1

SECTION 2

This section explains installation of options for this computer.

SECTION 2

SECTION 3

This section explains what to do when trouble occurs with this computer and when messages are displayed. Read this section as the necessity arises.

SECTION 3



CONTENTS

SECTION 1

1	Names of the Parts and their Functions	2
	Front	2
	Right Side	4
	Left Side	6
	Rear	7
	Bottom	9
	Connector Box	10
	Status Indicator LCD	12
2	Pointing Device	15
	Flat Point	15
	How to Use Flat Point	16
3	Keyboard	18
	Keyboard	18
	Numeric Keypad Mode	18
	Names of the Main Keys and their Functions	19
4	Switching on the Power	22
	Switching on the Power	22
5	Switching off the Power	24
	Switching off the Power	24
6	Resetting	27
	How to Reset	27
7	Battery	28
	Battery Charging	28
	Using PC with Battery	29
	Low Battery Status	30
	Replacing built-in Battery Unit	32

SECTION 2

1	Options	35
	Options	35
	Peripherals	36
2	PC Cards	37
	Precautions for PC Cards	37
	Setting PC Card	38
	Removing PC Card	40
3	Expansion RAM Modules	43
4	Mobile Multi-Bay Units	45
5	CD-ROM Drive	48
	Setting/Removing CD	48



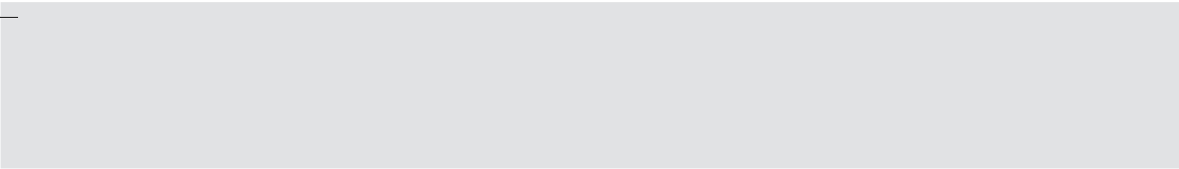

- 6 Connector Box 50**
 - Installing the connector box 50
 - Removing the connector box 51
- 7 Using Internal Data / Fax Modem 52**
 - Connection 52
- 8 Using Internal LAN 54**
 - Connection 54
- 9 Mouse 55**
 - Connecting PS/2 Mouse 55
 - Connecting USB Mouse 56
 - Disabling Flat Point 56
 - How to Use Mouse 57
- 10 Connecting Numeric Keypad / Keyboard / Mouse 58**
- 11 Printer 59**
 - Connecting Printer 59
- 12 Connecting External Display 61**
 - Connecting an external display 61
- 13 Connecting a TV Set (depend on model) 63**
 - Connecting a TV Set for Home Use 63
- 14 Using Digital Video Camera (depend on model) 64**
 - Connecting Digital Video Camera 64

SECTION 3

- 1 When This Happens 66**
- 2 Care and Maintenance 71**
- 3 Glossary 76**





SECTION

1

SECTION 1

This section explains basic operations and basic items for using this computer, including the names of the parts and their functions, Flat point operation methods, floppy disk unit handling, and battery operation.



SECTION 1

1 Names of the Parts and their Functions

Front

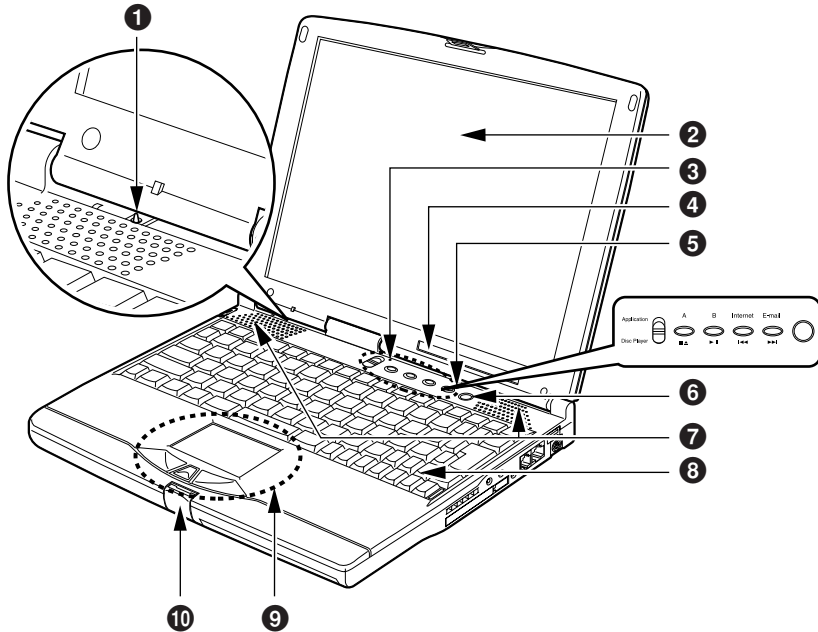

1 Cover close switch

This switch is used to suspend/resume the function of this PC unit and to turn off the LCD back light when you close or open the LCD display.

2 Liquid Crystal Display (LCD) Panel

Shows a full screen data from the computer main unit.

Critical Points

◆ Characteristic of LCD

The following natures are characteristic to LCD and you must not interpret them as defects.

- The TFT color liquid crystal display (LCD) of this PC has more than 2.35 million pixels or dots (in 1024 x 768 resolution), through the utilization of high-level technology. Because of this fact, the display may contain some unlit or continuously lit dots.
- The color tone of the LCD of this PC may differ among the units. And temperature change and other cause may results in some uneven color tone.



3 Built-in Microphone

You can record sound (monaural) with this microphone.

Critical Points

- ◆ You may experience feedback noise when you use minus-one music software and other software that uses simultaneously the microphone and speakers. In this case, adjust the sound volume or use a headphone or an external microphone available in stores. And set the microphone at "mute" position when you do not use it.
- ◆ The recorded sound from the built-in microphone may be not clear when the distance or the direction of the sound source is not appropriate. We recommend you to use an external microphone to record sound clearly.

4 Liquid Crystal Display (LCD) Panel

Shows a screenful of data from the computer main unit.

5 One-touch Buttons

These buttons are used to set application start-up, incoming E-mail receiving and Internet browser startup.

Critical Points

- ◆ To use the one-touch button, do not switch the MAIN switch off.
- ◆ Firmly hold the one-touch button until the application starts.

6 SUS/RES Switch

This switch is used to put it into suspend mode and to resume working.

7 Speakers

They output the sound from this PC unit.

8 Keyboard

You can input characters and give commands to the PC unit through this device.

9 Flat Point

You can manipulate the mouse pointer though this device.

10 Latch

This latch locks the liquid crystal display (LCD) against unintended opening. Unlock it to open the LCD.



Right Side

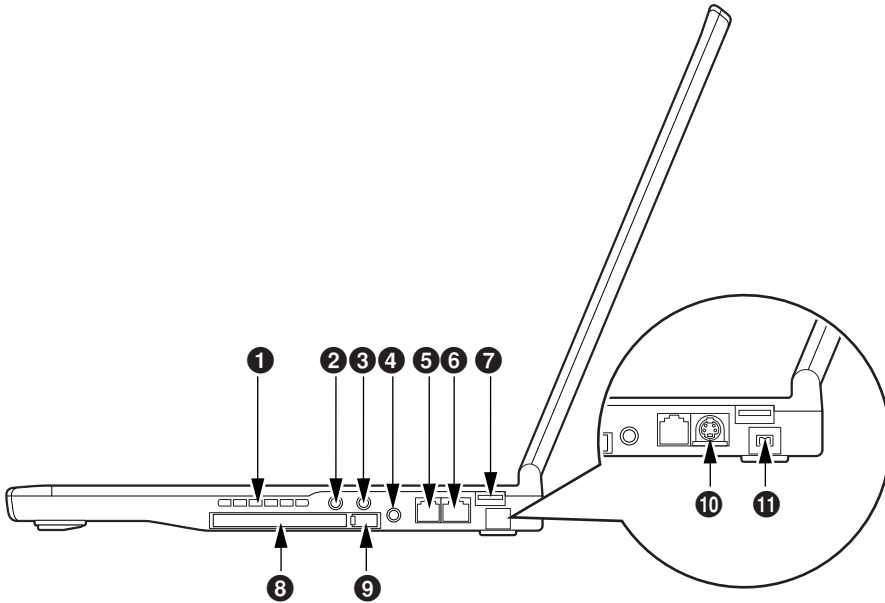

1 Ventilation Openings

The air-cooling fan gets air through these openings.

! CAUTION

HEARING LOSS



- Turn the sound volume level of the PC unit to the minimum prior to connection to the headphone, line-in, and mic-in jacks. Otherwise it may damage the equipment and/or your audibility may be adversely affected.

2 Mic-in Jack

It is the terminal to connect an external microphone to record sound (monaural, 3.5-mm mini plug type).

However, you cannot use some microphone in the market (eg. dynamic microphones). Please check its connectivity before purchase.

3 Line-in Jack

It is analog input (LINE IN) terminal to connect the PC to an output (LINE OUT) jack of an audio/visual device (stereo, 3.5-mm mini plug type).

4



4 Headphone Jack

It is the terminal to connect a headphone available in the market (3.5-mm mini plug type). However, you cannot use some headphone if its type is not compatible. Please check its connectivity before purchase.

CAUTION

HEARING LOSS



- Be careful not to use a headphone at excessive volume level, or it might give adverse effect to your audibility.

HEARING LOSS



- Do not turn on or off the power switch while you are wearing a headphone, or it might give adverse effect to your audibility.

5 Modular Connector

Some models have a modular connector.

This is the connector to connect the PC unit to telephone line by a modular cable to access Internet or PC BBS systems.

6 LAN connector

Some models are equipped with LAN connectors.

The LAN connector cannot be used while the PC has a connector box connected. Use the LAN connector of the connector box.

7 USB Connector (not supported by Windows NT)

You can connect a FDD unit, a printer and other USB standard peripherals to this connector.

8 PC Card Slot

Here insert the PC card you want to use.

Critical Points

- ◆ The manufacturer inserts a dummy card into the PC card slot before shipping.
- ◆ Some operating system calls "Slot 1" as "Slot 0"

9 PC Card Eject/Lock Button

Press this button to eject the PC card. It also has a locking function to prevent the inserted PC card from accidental removing.

10 S-Video output terminal (depend on model)

Some models are equipped with S-Video output terminals.

11 IEEE 1394 (DV) terminal (depend on model)

Some models are equipped with IEEE 1394 (DV) terminals. Via a DV cable, the terminal is used to connect the PC and peripheral devices such as a digital video (DV) camera.



Left Side

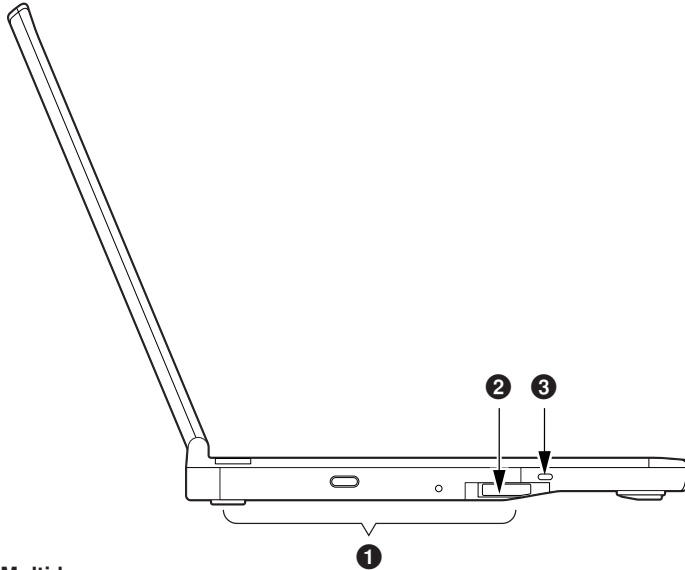

1 Mobile Multi-bay

One of the following units has been installed depending on the model:

- Built-in CD-ROM drive unit
- Built-in CD-R/RW drive unit
- Built-in PC card unit
- Mobile multi-bay cover

Those units may be replaced.

Critical Points

◆ Always use the PC with a unit set in the mobile multi-bay. Otherwise the PC may be damaged.

2 Mobile Multi-bay Unit Removal Lever

Erect this lever to remove the unit set in the mobile multi-bay.

3 Anti-theft Lock

You can connect an anti-theft cable available in the market to it

Critical Points

- ◆ This anti-theft lock is compatible with Micro Saver Security System from Kensington Ltd.
- ◆ The mobile multi-bay unit cannot be removed when an anti-theft cable is connected to the PC.



Rear

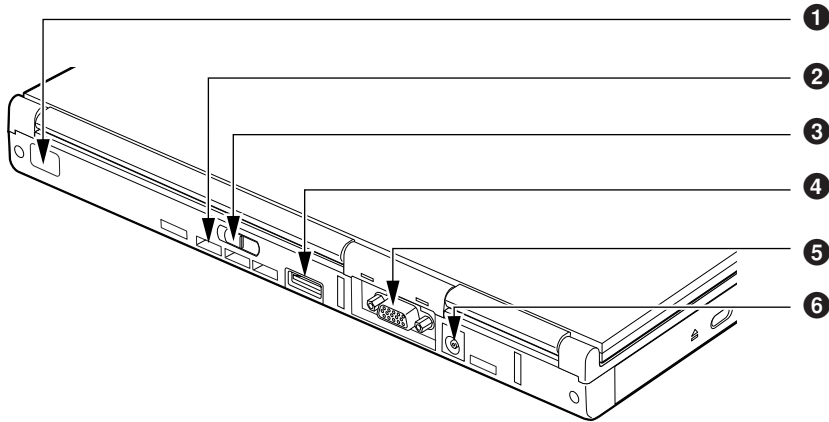

1 Infrared Communication Port (not supported by Windows NT)

It is the interface to conduct infrared communication.

Critical Points

- ◆ Do not put an AC adapter or an external display near from the infrared communication port when you are conducting infrared communication, or it cause malfunction due to noise from those devices.

2 Air-cooling fan

It is a fan to let out the heat from the inside of the PC unit. It starts rotating when the temperature of the inside of the PC unit is high.

CAUTION

FAILURE



- Do not cover the holes over the air-cooling fan, or the heat inside the PC unit might cause the machine failure.

3 MAIN Switch

The main power switch of the PC.

4 USB connector (not supported by Windows NT)

You can connect a FDD unit, a printer and other USB standard peripherals to this connector.



5 External Display Connector

This is the connector to connect a CRT display and other displays sold separately.

6 DC-IN Connector

This is the connector to connect the AC adapter.

IMPORTANT

When you connect an optional device to each connector, you must ensure the right direction of the connectors and connect straight.

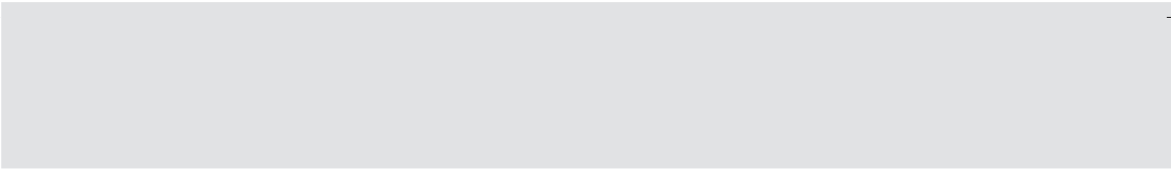

Bottom

SECTION 1

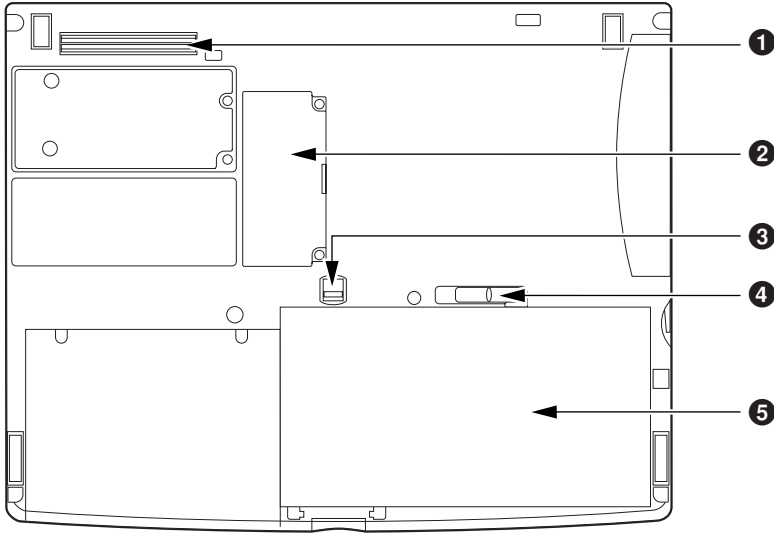

1 Connector box connector

This is the connector to connect the connector box.

2 Expansion RAM Module Slot

The memory unit of the PC is installed here. You may change the memory unit to increase the memory.

3 Release Button

Slide this button to release the built-in battery pack lock.

4 Built-in battery pack lock

Slide it to install/remove the built-in battery pack.

5 Built-in battery pack

The built-in battery pack is installed here.





Connector Box

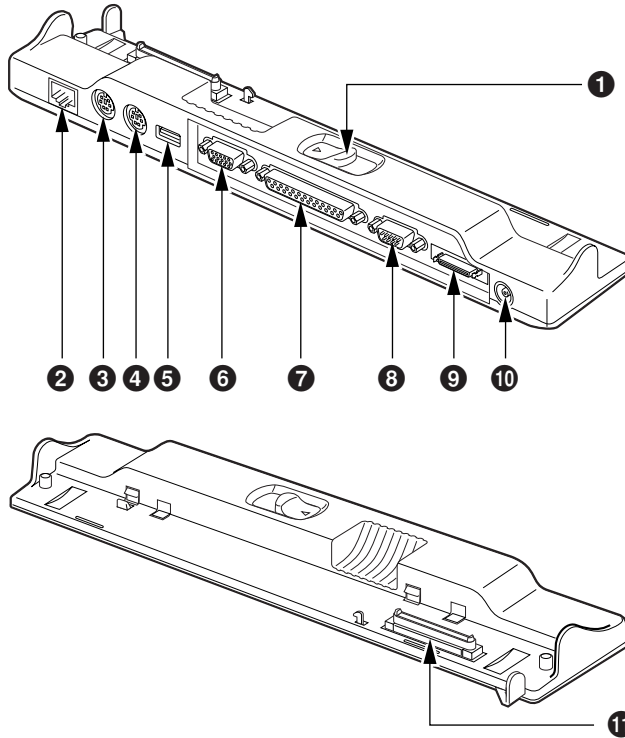

- 1 Connector Box Removal Lever**
Slide it to remove the connector box from the PC.
- 2 LAN Connector**
Some models are equipped with LAN connectors.
- 3 Expansion keyboard connector**
This is the connector to connect a PS/2 numeric keyboard.
- 4 Mouse connector**
This is the connector to connect a PS/2 mouse.
- 5 USB Connector (not supported by Windows NT)**
You can connect a FDD unit, a printer and other USB standard peripherals to this connector.

**6 External Display Connector**

This is the connector to connect a CRT display and other displays sold separately.

Critical Points

- ◆ The direction of the USB connector and the external display connector on the connector box is opposite to that of the connectors on the PC.

7 Parallel Connector

This is the connector to connect a printer and other devices sold separately.

8 Serial Connector

This is the connector to connect the separately sold devices with RS-232C interface.

9 FDD unit connector

This is the connector to connect the FDD unit.

10 DC-IN Connector

This is the connector to connect the AC adapter.

11 Connection connector

This is connected to the connector box connector on the PC.







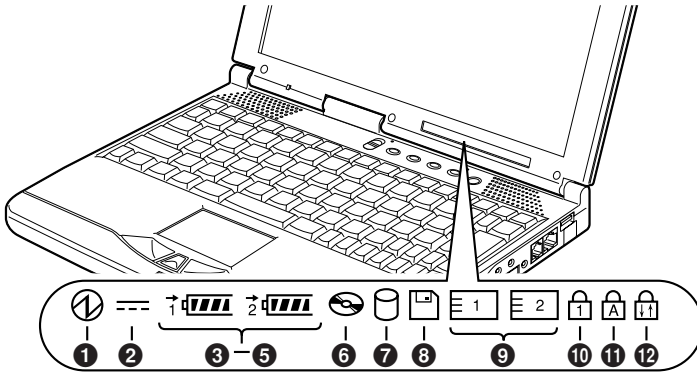

IMPORTANT NOTE

When you connect an optional device to each connector, you must ensure the right direction of the connectors and connect straight.



Status Indicator LCD



- 1 SUS/RES Indicator ()**
This indicator appears up when this PC unit is functioning and blinks when the unit is in suspend status.
- 2 AC Adapter Indicator ()**
This indicator appears when the power is supplied from AC adapter.
- 3 Battery Mounting Indicator (1, 2, )**
This indicator appears when batteries are mounted. "1" means the internal battery and "2" means the auxiliary battery in mobile multi-bay.
- 4 Battery Charge Indicator ()**
This indicator appears when batteries are charged. And it blinks when battery charge is not in progress because the batteries are too hot or too cold.
- 5 Remaining Battery Power Indicator ()**
Indicates the remaining power of the battery.
- 6 CD Access Indicator ()**
Goes on when accessing a CD, etc. See also POINT on the next page.
- 7 Hard Disk Access Indicator ()**
Goes on when accessing the internal hard disk. See POINT on the next page.
- 8 Floppy Disk Access Indicator ()**
Goes on when accessing a floppy disk or a super disk. See POINT on the next page.



IMPORTANT

When you connect a FDD unit (USB), the floppy disk access indicator in the status indicator LCD does not appear even a floppy disk is accessed. You should check the access to the floppy disk with the access lamp on the FDD unit (USB). Make sure that the access lamp does not light up when you eject a floppy disk.

9 PC Card Access Indicator ()

This indicator appears when a PC card is accessed. 1 indicates the PC card slot on the PC and 2 indicates the PC card slot of the built-in PC card unit installed on the mobile multi-bay. See POINT below.

10 Num Lock (Numerical Lock) Indicator ()

This indicator appears when the keyboard is set to numeric keypad mode. You can set and reset the numeric keypad mode by pressing the [Num Lk] key.

11 Caps Lock Indicator ()

Lights when the caps lock function is activated.
To switch the caps lock function on and off, press the [Caps Lock] key.

12 Scroll Lock Indicator ()

Lights when the screen is set not to be scrolled (scroll lock).
To switch the scroll lock function on and off, press the [Scr Lk] key while holding the [Fn] key.
The function of the PC depends on the application when this indicator appears.

Critical Points

- ◆ While the hard disk access indicator or the floppy disk access indicator lights, setting the MAIN switch off or pressing the SUS/RES switch may damage the data on the hard disk or the floppy disk (or the super disk).
- ◆ Setting the MAIN switch off causes all the indicators on the status indicator LCD to go off except when the battery is being charged.
- ◆ For some operation systems, you may have to read "Slot 1" of the PC card access indicator as "Slot 0" and "Slot 2" as "Slot 1".
- ◆ When you use Windows 98 / Windows Me and the CD auto insert function is enabled, the system periodically detects whether the slot has a CD. As a result, the CD access indicator on the status indicator LCD goes on periodically. To disable the CD auto insert function, take the following procedures:

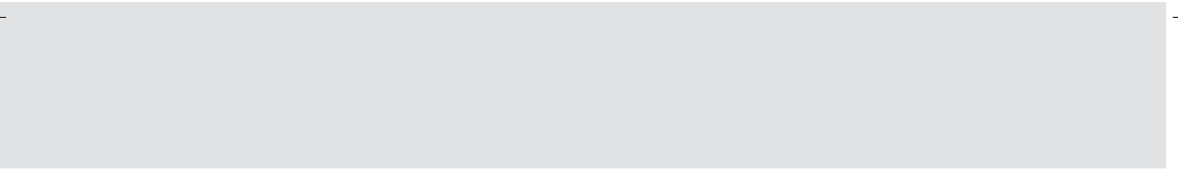

- 1 Click on the Start ->Settings -> Control Panel.
- 2 Click on the System icon
- 3 Click on the Device Manager tab.
- 4 Double-click on the CD-ROM.
CD-ROM device is indicated.
- 5 Click on the CD-ROM device and then click on the Properties.
The Properties of CD-ROM Device dialog box appears.
- 6 Click on the Setting tab.
- 7 Click on the Auto notification of insertion in Option to set it disabled.
- 8 Click on OK.
- 9 Click on OK or Close in the System Property dialog box to go back to the Control Panel window.
- 10 Restart the PC unit.
To enable auto notification, click on "Auto notification of insertion" in step 7 to put check mark on it.

2 Pointing Device

Flat Point

The flat point is a convenient pointing device, with which you can operate the mouse pointer with your finger movement. It consists of a touchpad and two buttons in front of it. The touchpad is equivalent to the ball of a mouse. Sliding your finger on it in a desired direction causes the mouse pointer to move in the same direction on the screen. Lightly tap on it for clicking, double-clicking, pointing, and dragging.

The left and right buttons are equivalent to those on a mouse and their functions depend on the application you are running.

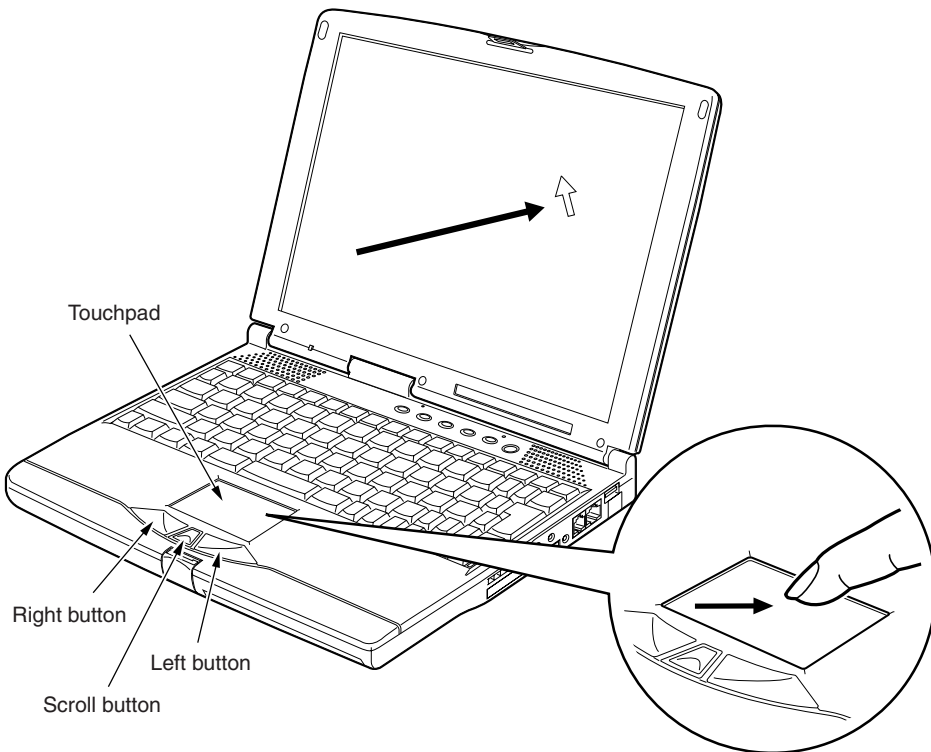

Critical Points

- ◆ The pointer movement of a flat point may differ a little due to the difference of the dryness of the finger tip of a user and other reasons.
- ◆ Dew drop and dirt on the touchpad may result in malfunction. In such a case, remove dew and dirt from the surface by wiping with dry soft cloth. And when the surface is excessively dirty, remove the dirt by wiping with a soft cloth soaked with diluted neutral detergent.
- ◆ When using a separately available mouse, you need to make settings such as simultaneous use of a mouse in the "Keyboard/mouse setting" window in the BIOS setup menu.



How to Use Flat Point

● Clicking

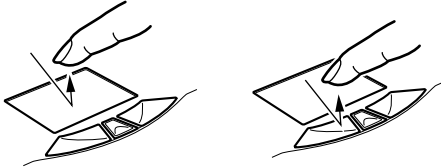

Clicking means to tap the touchpad once or to push the left button once and release it at once. And “right click” means to push the right button once.

● Double-clicking

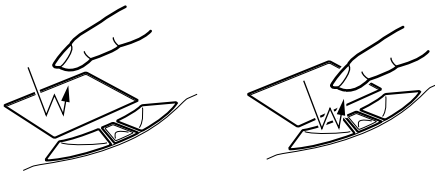

Double-clicking means to tap the touchpad twice consecutively or to push twice the left button quickly and release at once. The speed of double-click can be adjusted in the Mouse Properties dialog box.

● Pointing

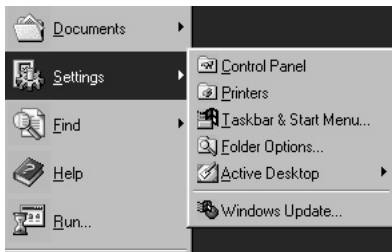

Pointing means to set the mouse pointer over menu and other icons on the screen. When you set the mouse pointer on a menu and if the menu has sub-menu under it (indicated with ► mark on the right end of the menu), the sub-menu appears.

● Dragging

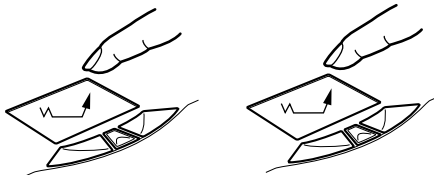

Dragging means to move the mouse pointer to your favourite place and tap the touchpad twice quickly. In the second tap, you must not release your fingertip from the surface and move it to the appropriate position, then release your fingertip. Or you may move the mouse pointer to your favourite position and move your finger tip on the surface of the touchpad with holding down the left button, then release your finger tip.



● Scrolling

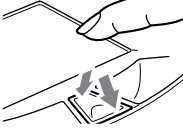

Scrolling up (going backward):
Press the button towards the LCD display.

Scrolling down (going forward):
Press the button towards you.

To scroll the display on the screen, click on the area at which you want to start scrolling, then press the scroll button forward or backward.

Critical Points



- ◆ The above operation descriptions are applied when the right-hander option has been selected in the Mouse Properties dialog box.
- ◆ When tapping, use the tip of a finger and tap lightly and quickly. You do not need a strong tap.
- ◆ When using the flat point to move the mouse pointer on the screen, it does not move even if you release your finger once and put it on a different position on the flat point. Sliding it again from that position towards another causes the mouse pointer to move in the same direction on the screen.

SECTION 1

3 Keyboard

Keyboard

The keyboard is the device for giving instructions to the computer, inputting data, and executing. The keys can be divided into two types.

-  : Control keys
-  : Character keys

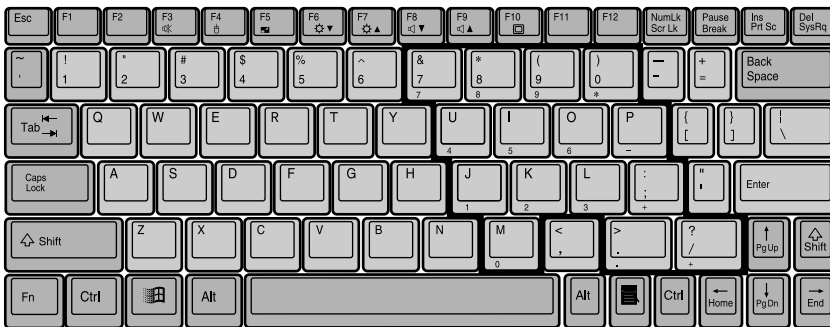

Numeric Keypad Mode

The mode in which some of the character keys are used as numeric keys (with a key layout that makes numeric input easier) instead of their normal functions is called numeric keypad mode. The keyboard is switched to numeric keypad mode with **[Num Lk]**. (In numeric keypad mode,  is displayed on the status indicator LCD.) The keys surrounded by thick lines in the diagram above become the numeric keypad. The numbers input with these keys are printed in pink on the front of each key.

Critical Point

- ◆ When the separately sold numeric keypad is connected, if you press [Num Lk] to put the computer into numeric keypad mode, the keys on the external numeric keypad are enabled, but the numeric keypad section on the keyboard is disabled.



Names of the Main Keys and their Functions

[Esc] (escape) key

The usage is determined by the application software. It is often used to return to the previous operation.

[F1]-[F12] (function) keys

The usage depends on the application software.

[Fn] key

A key unique to this computer; it has the following functions.

- [Fn] + [F3]** This switches ON/OFF of the speaker.
When a pip sounds with this operation, the speaker is on. When nothing sounds, the speaker is turned off.
- [Fn] + [F4]** This select to disabled the touch pad mouse when you attached an external mouse.
- [Fn] + [F5]** This selects whether or not to use the entire LCD display panel for display in text mode.
- [Fn] + [F6]** Turns down the backlight of the LCD.
- [Fn] + [F7]** Turns up the backlight of the LCD.

Critical Point

- ◆ Luminance of the backlight of the LCD can be turned up (with [Fn] + [F7] keys) or turned down (with [Fn] + [F6] keys) in three degrees.

- [Fn] + [F8]** Turn down the internal speaker volume.
- [Fn] + [F9]** Turn up the internal speaker volume.
- [Fn] + [F10]** Rotates among the three display options: LCD only, CRT only, both LCD and CRT.

[Space] key

Inputs a single space character.
(This is the long key with nothing written on it at the center of the front of the keyboard.)

[↑] [↓] [←] [→] (cursor) keys

Move the cursor.

[Enter] key

Also called the return key or the line feed key. This key inputs line feeds and executes command.

[Ctrl] (control) key

Used in combination with other keys; its functions depend on the application software.



[Shift] key

Used in combination with other keys.

[Alt] key

Used in combination with other keys; its functions depend on the application software.

[Caps Lock] key

To lock the keyboard into caps mode, press this key. Pressing this key again ends caps mode.

[Num Lk] (numerical lock) key

Press this key to put the computer into numeric keypad mode.

[Scr Lk] (scroll lock) key

Its functions depend on the application software.

[Print Screen] key

Press this key to make a hard copy of the screen.

[Pause] key

Press this key to pause the screen display.

[Break] key

Its functions depend on the application software.

[Insert] key

Press this key to insert a new character between characters. The new characters are entered at the cursor position.

[Delete] key

Press this key to delete a character. Pressing the Delete key and the **[Ctrl]** and **[Alt]** keys at the same time resets this computer.

[Home] key

Press this key to move the cursor directly to the head of the row or the head of the document.

[End] key

Press this key to move the cursor directly to the end of the row or the end of the document.

[Page Up] key

Press this key to switch to the previous screen.

[Page Down] key

Press this key to switch to the next screen.

[Back Space] key

Press this key to delete the character to the left of the cursor position.

[Sys Rq] (system request) key

When this key is supported by the application software, this key is used for such functions as resetting the keyboard. Press this key together with the Alt key.

[] (Windows) key

Press this key to display the Start menu.

[] (Application) key

Press this key to display the shortcut menu for the selected item. This key has the same role as the mouse right click.

SECTION 1

4 Switching on the Power

Switching on the Power

Here is the explanation of the normal method to put on the power of this PC unit.

IMPORTANT NOTE

- Once switching the PC power on, do not carry the PC or cause it to be shocked or vibrated in any way. It can cause a damage.
- Do not switch the PC power on while no unit is installed in the mobile multi-bay. It can cause a damage.
- If your PC is connected with a FDD unit and a floppy disk is set in it, eject it before switching the PC power on.

1 Connect the AC adapter.

Connect the power cable to the AC adapter (1) and insert the mini plug in the DC-IN connector on the PC (2). Then put the plug in a receptacle (3).

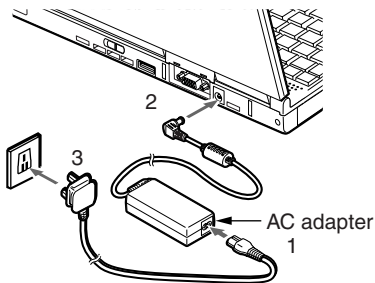

2 Open the LCD display.

Press and unlock the front latch and lift the LCD display with hands.

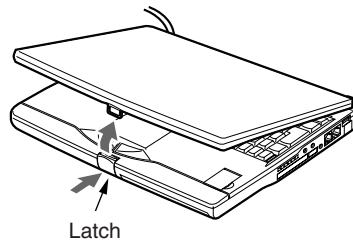

3 Switch the PC MAIN switch on.

This causes the PC power to be switched on and the POST (Power On Self Test) to start. Some indicators on the status indicator LCD go on.

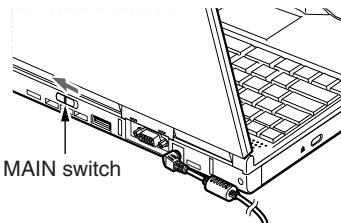



IMPORTANT NOTE

- Pay attention to the following points when the PC power is on:
 - Do not cover the keyboard with paper or the like.
It may interfere with the heat dissipation, causing a malfunction.
 - After using the PC for a long time, you may feel that the PC surfaces are warm. This is because the PC is designed to dissipate the internal heat from the entire body, including the keys on the keyboard, once a certain heat level has been exceeded. So it is not abnormal.
 - Depending on the use condition, the bottom surface of the PC may be hot. Do not use the PC for a long time in a condition where the bottom surface touches part of your body, e.g., placing it directly on the lap.
 - Do not block the air-cooling fan openings, e.g., putting an object in front of them. It may cause the PC to be damaged.

Critical Points

- ◆ POST stands for “Power On Self Test” and is a self-diagnosis test performed to ensure that no abnormality exists in the PC. POST automatically starts after the PC power is switched on and completes immediately before the operation system starts.
- ◆ If you switch the PC power off while POST is running, it is detected that POST is terminated abnormally. The PC counts the number of abnormal POST terminations. If the PC detects three continuous abnormal POST terminations, it will give you an error message when you start the PC for the fourth time. Pay attention not to accidentally switch the PC power off while the PC is performing POST.



SECTION 1

5 Switching off the Power

Switching off the Power

IMPORTANT NOTE

- Only set the MAIN switch off after you exit from the operation system and the SUS/RES indicator on the status indicator LCD goes off.
- To set the MAIN switch off while suspending, resume the PC, save the data, and terminate the operation system in advance.
- When you switch the PC power off and on again, wait for about ten seconds before switching it on.
- Remove any CD, floppy disk, and the like prior to switching the PC power off.
- Set the MAIN switch off for the following purposes:
 - Carrying the PC
 - Installing/removing peripheral equipment
 - Corresponding to low battery or saving the power

☐ For Windows Me and Windows 98

- 1 **Click on the “Start” button then “ Exit Windows “.**
The “ Exit Windows “ dialog box will appear.
- 2 **Ensure that “ Shut Down“ is selected for Windows Me, “Shut Down” for Windows 98 Click on “OK” or “Yes”.**
This causes the operation system to be terminated and the PC power to be switched off. Also the SUS/RES indicator () on the status indicator LCD goes off.

Critical Points

- ◆ If you do not set the MAIN switch off after Step 2 above, you can switch the PC power on again simply by pressing the SUS/RES switch.
- ◆ To use the one-touch button, do not take Step 3 below.
- ◆ If you select “Restart”/“Restart computer” on the screen displayed in Step 1, the PC can be restarted. Restarting means that the PC once deletes the data that has been put in the memory and re-reads the operation system from the floppy disk or the hard disk.
- ◆ For Windows Me and Windows 98 selecting “Standby” or “ Idle status “ causes the PC to enter the power saving mode.

**3 Set the MAIN switch off.**

Slide the MAIN switch in the direction indicated by the arrow.

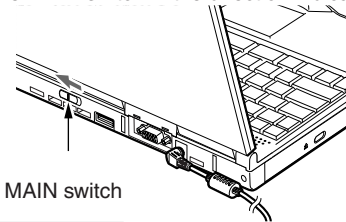
**Critical Points**

- ◆ If you do not use the PC for a long time after this, remove the AC adapter and the battery pack.

For Windows 2000:**1 Click on the “Start” button then the “Shutdown” option.**

The “Windows shutdown” dialog box will appear.

2 Select “Shutdown” then click on “OK”.

The PC power will automatically be switched off.

Critical Points

- ◆ If you do not set the MAIN switch off after Step 2 above, you can switch the PC power on again simply by pressing the SUS/RES switch.
- ◆ If you select “Restart” on the screen displayed in Step 1, the PC can be restarted. Restarting means that the PC once deletes the data that has been put in the memory and re-reads the operation system from the floppy disk or the hard disk.
- ◆ To use the one-touch button, do not take Step 3 below.
- ◆ Selecting “Standby” or “Pause” on the screen displayed in Step 1 causes the PC to enter the power saving mode.
- ◆ Alternatively, you may switch the PC power off according to the following procedures:
 - 1 Press [Delete] key while holding down [Ctrl] and [Alt] keys.
The “Windows security” dialog box will appear.
 - 2 Click on “Shutdown”.
The “Windows shutdown” dialog box will appear.
 - 3 Select “Shutdown” and click on “OK”.
The PC power will automatically go off.



3 Set the MAIN switch off.

Slide the MAIN switch in the direction indicated by the arrow (○ side).

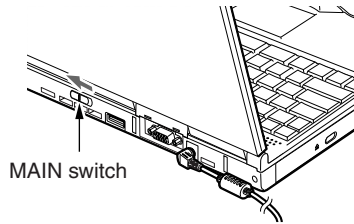

Critical Points

- ◆ If you do not use the PC for a long time after this, remove the AC adapter and the battery pack.



SECTION 1

6 Resetting

How to Reset

Resetting the PC is required after installing an application or if the software you are currently running freezes by any reason.

Critical Points

- ◆ Resetting the PC causes the data in the memory to disappear. Necessary data should be saved prior to PC resetting.

❑ For Windows Me, Windows 98

- 1 **Click on the “Start” button then “Windows termination”.**
The “Windows termination” dialog box will appear.
- 2 **Select “Restart” then click on “OK” or “Yes”.**
The PC will be reset.

Critical Points

- ◆ Should the PC not be reset by the above procedures, take the following step:
 - Press [Delete] key while holding down [Ctrl] and [Alt] keys.
 - When the Terminate Application dialog box appears, follow the instructions.

❑ For Windows 2000:

- 1 **Click on the “Start” button then “Shutdown”.**
The “Windows shutdown” dialog box will appear.
- 2 **Select “Restart” then click on “OK”.**

Critical Points

- ◆ Alternatively, you may reset the PC according to the following procedures:
 - 1 Press [Delete] key while holding down [Ctrl] and [Alt] keys.
The “Windows security” dialog box will appear.
 - 2 Click on “Shutdown”.
The “Windows shutdown” dialog box will appear.
 - 3 Select “Restart” and click on “OK”.
The PC power will be reset.

❑ For Windows NT:

- 1 **Click on the “Start” button then “Shutdown”.**
The “Windows shutdown” dialog box will appear.
- 2 **Select “Restart computer” then click on “Yes”.**
The PC will be reset.

Critical Points

- ◆ Alternatively, you may reset the PC according to the following procedures:
 - 1 Push down the [Delete] key while pressing down the [Ctrl] and [Alt] keys.
 - 2 When the Windows NT security dialog box appears, click “Shutdown”.
 - 3 When the Shutdown the Computer dialog box appears, select “Restart after Shutdown” and click on OK. This PC is reset.

SECTION 1

7 Battery

Battery Charging

Considering mobile use, the PC has been designed so that it can be supplied with power from a battery besides the AC adapter.

1 Connect the AC adapter.

Connecting the AC adapter starts charging, causing the battery charging indicator and the battery remaining power to be shown on the status indicator LCD.

2 After ensuring that the battery charging indicator has disappeared, remove the AC adapter.

Critical Points

- ◆ After purchasing the PC or if you have not charged the battery for more than a month, charge it before use.
- ◆ Battery charging completes when the battery charging indicator (→) disappears and the battery remaining indicator () on the left changes from flashing to lighting. Spend enough time so that the battery is fully charged.
- ◆ When the battery remaining power is 90% or more, the battery is not charged if the AC adapter is connected. Charging starts when the remaining power is 89% or less.
- ◆ When the MAIN switch is set off, the indicators on the status indicator LCD disappear awhile after charging completes.
- ◆ The battery charging performance may lower if the environmental temperature is too high or too low.
- ◆ The battery temperature is high immediately after use. Charging it under this condition may be impossible due to the protection function of the battery (→ flashes). Charging will start awhile after the battery temperature lowers.
- ◆ If you have an additionally mounted battery, it is also charged at the same time.

Using PC with Battery

You can check the remaining battery power through the remaining battery power indicator in the status indicator LCD when the power is on or while charging is in progress.



Remaining battery power indication

-  It means that the remaining battery power is about 100% to about 76%.

↓
-  It means that the remaining battery power is about 75% to about 51%.



↓
-  It means that the remaining battery power is about 50% to about 26%.

↓
-  It means that the remaining battery power is about 25% to about 13% (It represents 0% to about 25% of remaining battery power during charging).

↓
-  It means low battery status (the remaining battery power is about 12% or less).  blinks. Alarm sounds for Windows 98, Windows Me and Windows NT.

↓
-  It means that battery is completely exhausted (The remaining battery power is 0%).

Critical Points

- ◆ The remaining battery power indicator () may show the different indicator value from the actual remaining battery power depending on the usage environment (temperature condition, battery usage and recharging cycle numbers, etc) because of the characteristic of the battery (lithium ion battery).
- ◆ Charging does not start even though the AC adapter is attached when the remaining battery power is 90% or more. Charging starts when the power is 89% or less.
- ◆ "1" in the battery mounting indicator () means the internal battery.

Battery abnormality indicator

-  It means that the battery is not charged properly.

Critical Points

- ◆ When  blinks, turn off the power of the PC unit and reinstall the battery. When the blinking persists, the battery is defective. Replace it with a new battery.



Low Battery Status

This section describes the indication of low battery status and how to treat it.

□ Indication of low battery status

The remaining battery power indicator blinks in the status indicator LCD ().

Critical Points

- ◆ For Windows 98, Windows Me and Windows NT, the system generates an audible alarm for a low battery condition. However, you may not hear it if the sound level is low.
- ◆ The alarm is not audible if the loudspeaker is set off.
- ◆ To switch the loudspeaker on and off, press the [F3] key while holding down the [Fn] key. It is on when you hear a beep and off when not.

□ Countermeasure against Low Battery Status

1 Press the SUS/RES switch (Take Step 2 for Windows NT).

If you find the battery is low, press the SUS/RES switch to suspend (pause) the PC as soon as possible. Suspending it during operation does not delete any program and data.

Critical Points

- ◆ For Windows 2000 do not set “When pressing computer power button” to “Power off” on the “Details” tab of “Power option property”. If “Power off” is selected, the PC power goes off when you press the SUS/RES switch, resulting to deletion of data.
- ◆ For Windows 98 do not set “When pressing computer power button” to “Shutdown” on the “Details” tab of “Power management property”. If “Shutdown” is selected, the PC power goes off when you press the SUS/RES switch, resulting to deletion of data.
- ◆ If you are using Power Panel with Windows NT, pressing the SUS/RES switch can suspend the PC.

2 Connect the AC adapter.

Battery charging starts when the AC adapter is connected.

Critical Points

- ◆ Much power is consumed for reading from/writing to the hard disk. If the battery is in a low condition, use the AC adapter to save your data to the hard disk.
- ◆ Leaving the PC in a low battery condition causes the PC to be suspended. However, if you are reading data from or writing to the hard disk, etc., the PC is not suspended until the operation completes.
- ◆ If you keep using the PC in a low battery condition, the data that is being generated or saved may be lost at the worst. Connect the AC adapter immediately. If you do not have any AC adapter, press the SUS/RES switch to resume the PC, then switch the PC power off.

3 Press the SUS/RES switch.

It causes the PC to be resumed and ready for re-operation.

Critical Points

- For Windows 2000 and Windows 98 the PC is automatically suspended if the battery power is reduced to 13%.

CAUTION

ELECTRIC SHOCK



- Battery is a very delicate product. Do not give strong shock by dropping and other mishandling during installation and removal. And do not use the battery which was given strong shock in consideration of safety, or it leads to electric shock and rupture of the battery.

Discharge

- We recommend to charge a battery just before its use because it gradually discharge little by little even though you do not use it after charging.
- Remove the battery and store it in a cool place if you are not going to use this PC for a longer time (about 1 month or more). The battery discharges excessively and it results in the shorter battery life if it is left inside the PC for a longer period.

Battery Life

- The battery is deteriorating even when you do not use the PC unit for a longer period. Use the PC unit with the battery once a month to check the battery condition.
- Because the battery is consumable item, its charging capacity deteriorates after a longer usage.
- When the battery power duration becomes excessively short, it means that the battery life ends.

Battery Disposal

- When you dispose the battery, insulate the battery terminal with tape to avoid electric short and dispose it in the accordance to the local government ordinances and rules.

To Prolong the Battery Life

- Use power saving feature.

When the battery operating time becomes shorter

- When you use the battery for a longer time, its recharging capacity deteriorates. Replace with a new one in such a case.

Use the AC adapter in the following cases

- When you use the hard disk, a CD, a super disk frequently.
- When you use LAN and the modem frequently.
- When you set the PC status back to the original condition upon purchase.



Replacing built-in Battery Unit

Prior to replacing the built-in battery pack, it is required to save the programs and data to the hard disk, etc. This section describes how to replace the built-in battery pack.

WARNING

Electric shock



- Before replacing the built-in battery pack, be sure to switch the PC power off and disconnect the AC adapter. Do not touch the connectors on the PC and the battery pack.

1 Switch the PC power off and disconnect the AC adapter.

2 Close the LCD display and turn the PC over.

3 Release the lock.

To release the lock, slide the release button (1) on the bottom surface and the built-in battery pack lock (2) at the same time.

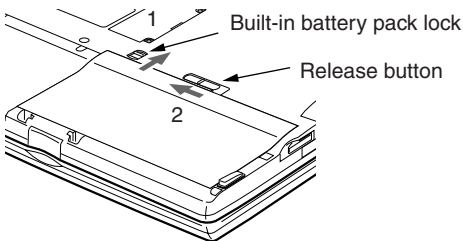



4 Remove the built-in battery pack.

To remove the built-in battery pack, put a finger in the dimple that appears after sliding the built-in battery pack lock.

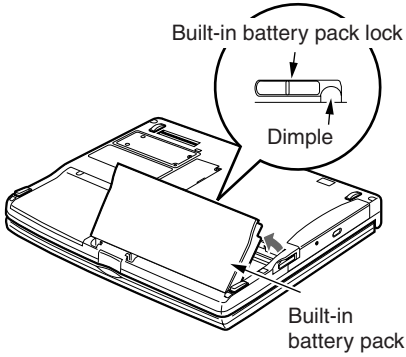

5 Install the new built-in battery pack.

Insert the new built-in battery pack diagonally then firmly push it inwards.

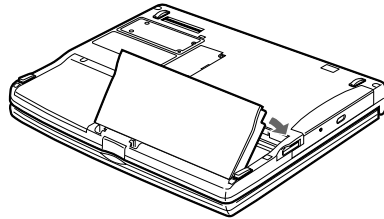

6 Slide the built-in battery pack lock until you hear a click.

Slide the built-in battery pack lock to the rightmost position (1) and ensure that the red marking on the release button has disappeared (2).

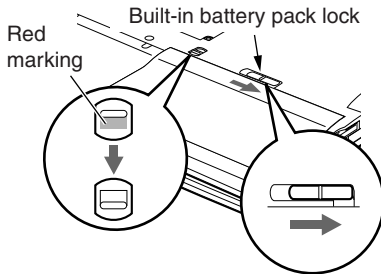



SECTION

2

SECTION 2

This section explains installation of options for this computer.

SECTION 2

1 Options

Options

You can expand the functions of this computer by connecting various options.

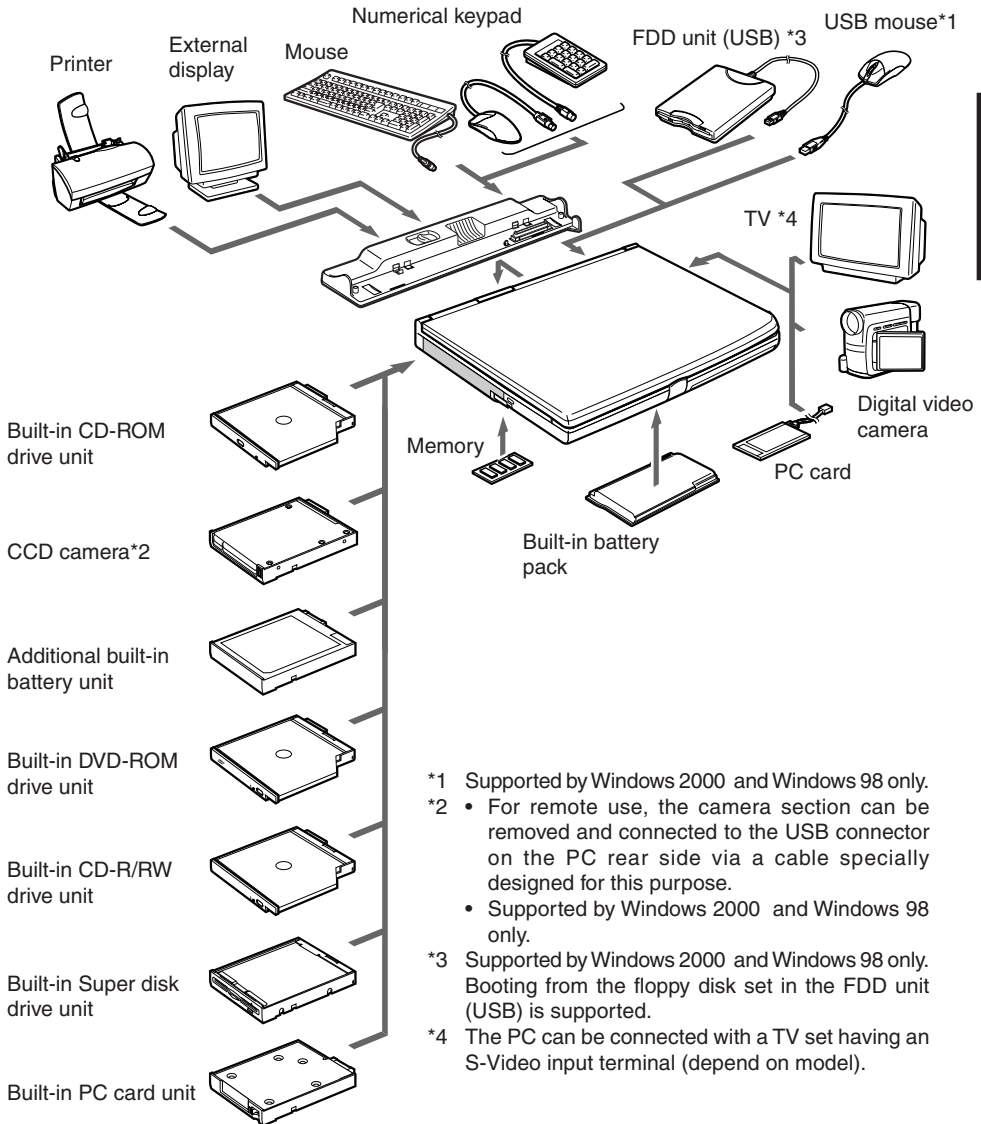

SECTION 2



Peripherals

Below explanation is necessary for your knowledge before connecting your peripherals.

- **Some setting up works are required for a certain peripherals**
You cannot use some PC peripherals just by connecting it to a PC. Those peripherals require some setting up work after connection. For example, printers and PC cards require “driver installation” work after connecting them. And memory and other peripherals do not require such setting up works. Make sure to consult with this document for the peripheral connection to complete the work correctly.
- **See also the documents for the peripherals**
The peripheral installation methods shown in this document are only a few examples. Make sure to consult with the documents for the peripherals as well as this document.
- **Use genuine products**
See “System Diagram” for the genuine optional device from our company. We cannot guarantee proper function on this PC for the peripherals from other sources. When it is necessary to use the peripheral from the other source, consult with the manufacturer of the product.
- **Use the peripherals that conform to ACPI standard**
This PC is set to ACPI mode for Windows 2000 and Windows 98. Power save and other functions may not work correctly if a peripheral does not conform to ACPI mode.
- **Notes on installation/removal**
The installation of the peripheral must be done after the setting up of an operating system except for a PS/2 mouse. The set-up function might not complete correctly if such a peripheral is attached before the operating system set up.

Critical Points

- ◆ When you connect a peripheral to a connector, make sure that the direction of the connection is correct and connect straight.
- ◆ When you connect more than one peripherals, complete setting for each peripherals before installing others.



SECTION 2

2 PC Cards

Precautions for PC Cards

Observe the following points when using PC cards to prevent breakdown.

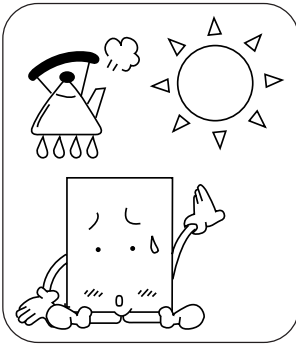

Do not place PC cards in high-temperature locations and locations subject to direct sunlight.

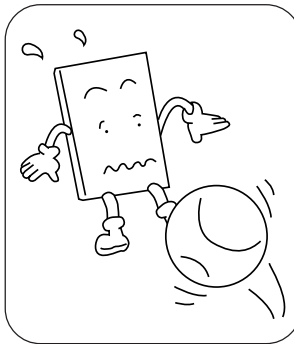

Do not subject PC cards to strong shocks.

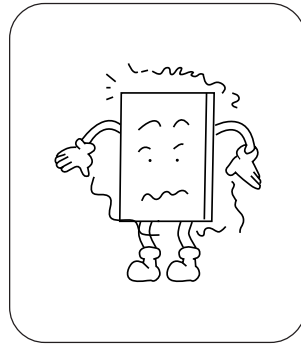

Avoid rubbing PC cards and building up static electricity.

SECTION 2



Do not place heavy objects on top of PC cards.

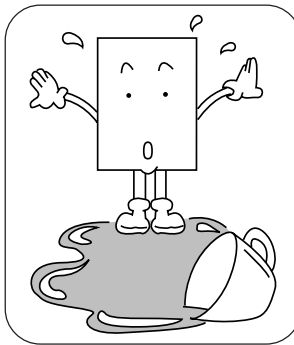

Be careful to avoid spilling coffee and other liquids on PC cards.

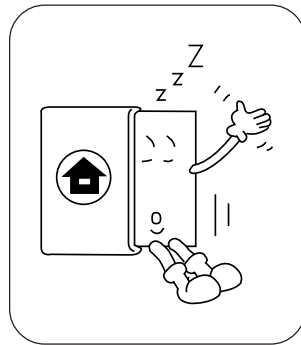

When storing a PC card, always place it in its special case.



Critical Points

- ◆ The examples of common PC card are as following:
 - SCSI card
It is the PC card required connecting a hard disk, an MO (magneto optical disk) drive and other SCSI-standard devices.
 - LAN card
It is the PC card required connecting PCs to share data and a printer.
- ◆ A certain PC card does not allow using 2 cards simultaneously. Those cards are seen among LAN card, modem card and other communication cards. Check the document for the PC card.
- ◆ This PC unit does not support PC cards that require 12V-power supply.

Setting PC Card

PC card is a card of the size of a calling card, with modem and other peripheral functions. Here is the explanation on how to set a PC card.

CAUTION

Injury



- Do not insert your fingers in the PC card slot when setting a PC card. It may cause an injury.

Critical Points

- ◆ Some PC cards require shutting down regardless of the type of your operating system or require the installation of a device driver. Consult with the documentation of the PC card.
- ◆ In the case of Windows NT, the slot number of a PC card displayed in the property dialog for the PC card is different from that displayed in the status indicator LCD.

1 For Windows NT, switch the PC power off and remove the AC adapter.

2 Remove the dummy card from the PC card slot.

Raise the PC card removal/lock button and press it to remove the dummy card.

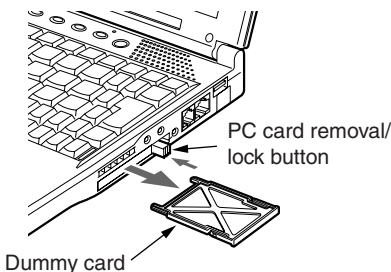

3 Insert a PC card.

Firmly insert the PC card in the PC card slot, with the product name label side facing upward.

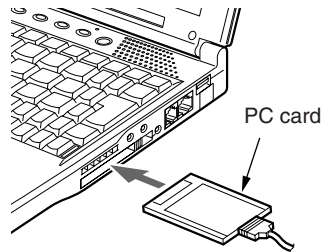



4 Lock the PC card.

Fully pull out the PC card removal/lock button then set it in the lock position.

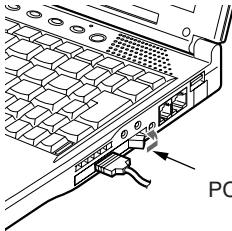

PC card removal/lock button

5 As for Windows NT, connect the AC adapter and switch the PC power on.

6 If the PC card is set for the first time, install the driver if needed.

Some PC cards need installation of the driver. Install the driver according to the manual of the PC card. In some cases, floppy disk(s) or CD(s) are necessary to install the driver.

Critical Points

- ◆ Do not put an object on the connecting part between the PC card and the cable nor give the part a shock. It may cause a damage.



Removing PC Card

Here is the explanation on how to remove a PC card in various operating systems.

Critical Points

- ◆ When you remove a PC card attached with a cable, do not pull the cable connected to the PC card, or it results in machine failure.
- ◆ When you remove a PC card, follow the following procedures, or it results in machine failure.
- ◆ Some PC cards require shutting down when you remove it. Consult with the documentation of the PC card.

Windows 2000

CAUTION

HIGH TEMPERATURE



- A PC card may be quite hot right after its usage. Wait for a while before removing a PC card after Step 3, or your fingertip might be burned.

INJURY



- When you remove a PC card, do not insert your finger into the PC card slot, or it may cut your fingertip.

- 1 Click on the **Unplug or Eject Hardware** icon on task bar.
- 2 Click **“Stop XXXXX”**.
- 3 Click on **“OK”**.
- 4 **Raise the PC card removal/lock button.**

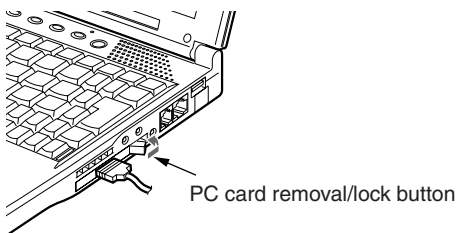



5 Remove the PC card.

Press the PC card removal/lock button to remove the PC card.

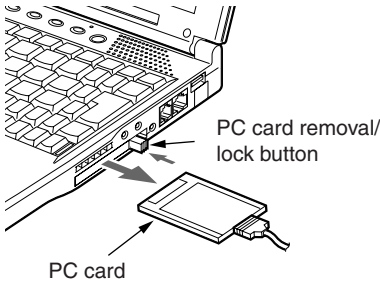

6 Set the dummy card.

Firmly insert the dummy card in the PC card slot. Fully pull out the PC card removal/lock button then lay it towards the front side to lock the dummy card.

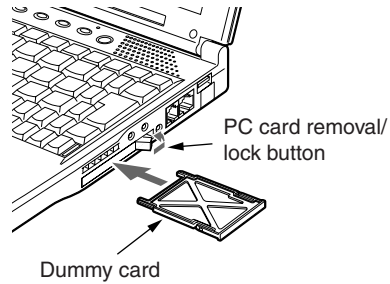

Windows 98 and Windows Me

CAUTION

HIGH TEMPERATURE



- A PC card may be quite hot right after its usage. Wait for a while before removing a PC card after Step 3, or your fingertip might be burned.

INJURY



- When you remove a PC card, do not insert your finger into the PC card slot, or it may cut your fingertip.

1 Click on the "PC card" icon on the task bar.

Critical Points

- ◆ Do not remove a PC card by double-clicking the PC Card icon on task bar or by clicking on Stop in the Property of PC Card (PCMCIA) dialog box which appears by the click on the PC Card icon in Control Panel, or it may cause the function of the PC unit unstable.

2 Click on Stop XXXXXX.

The name of your PC card is indicated in the XXXXXX part. The PC card will stop operation and the following box will appear.





Critical Points

- ◆ For some PC cards, the PC may give you a message “This device cannot be removed”. In this case, switch the PC power off and go to Step 4 for Windows 2000.

3 Click on “OK”.

4 Remove the PC card.

To remove the PC card, refer to Steps 4 to 6 for Windows 2000.

Windows NT

CAUTION

HIGH TEMPERATURE



- A PC card may be quite hot right after its usage. Wait for a while before removing a PC card after Step 1, or your fingertip might be burned.

INJURY



- When you remove a PC card, do not insert your finger into the PC card slot, or it may cut your fingertip.

1 Switch the PC power off and disconnect the AC adapter.

2 Remove the PC card.

To remove the PC card, refer to Steps 4 to 6 for Windows 2000.



SECTION 2

3 Expansion RAM Modules

If you increase memory capacity, you will be able to handle larger data and the PC performance will be enhanced when multiple applications are running simultaneously.

☐ Replacing Memory

This section explains how to replace the memory installed in your PC.

WARNING

ELECTRIC SHOCK



- Always turn off the power to the PC and disconnect the AC adapter when replacing memory, or you may get electric shock.

SWALLOWING



- Make sure to keep the small parts that you removed such as a cover, caps and screws, away from small children. If a child swallows any of those parts by accident, he or she may suffocate. Parents should take extra care to keep those parts out of children's reach.
- Should a child swallow a small part by accident, see a medical doctor as soon as possible.

CAUTION

FAILURE



- Hold the edge of memory not to touch its terminal and IC while you replace it. And do not touch the parts and terminals inside the PC unit. Fat substance on your fingertip might results in improper contact.

FAILURE



- A memory is composed of parts very sensitive to static. It may be destroyed by the static on a human body. Discharge static from your body by touching metal object before handling a memory.

FAILURE



- Always turn off the power to the PC when you replace memory. If you replace it in Standby or Suspend Mode with Windows 2000 or Windows 98, unsaved data will be lost or the PC or the memory may become faulty.

IMPORTANT NOTE

- When you unscrew the screws on your PC, use the cross-point screwdriver with the appropriate size for the screws. Using screwdrivers other than that may damage the head of screws.



- 1 Switch the PC power off and disconnect the AC adapter.
- 2 Close the LCD display and turn the PC over.
- 3 **Remove the two screws and remove the extended RAM module slot cover.**
Remove the extended RAM module slot cover that is mounted on the PC rear surface.
- 4 **Remove the memory.**
Press outwards the two tabs that hold the memory and take the memory out.

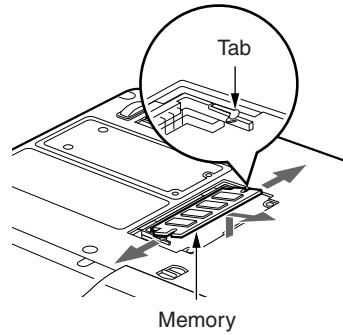
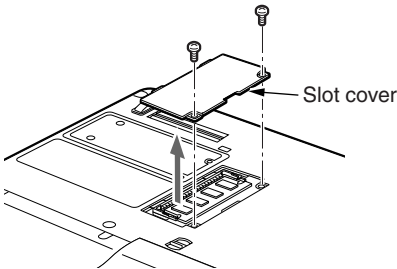

- 5 **Install the new memory.**
Fit the notch in the memory to the lug on the connector and firmly insert the memory in a diagonal direction until you hear a click.
- 6 **Install the extended RAM module slot cover.**
Install the cover that was removed in Step 3.

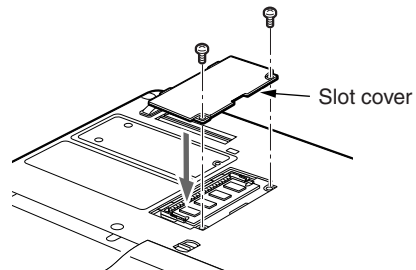
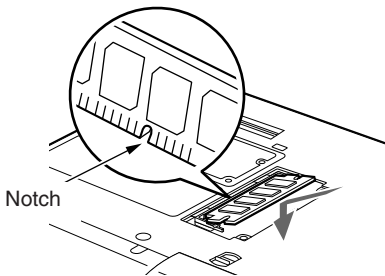

IMPORTANT NOTE

- Incorrect installation of a memory may cause a message “Extended memory error” or the screen will display nothing after switching the power on. In this case switch the PC power off using the MAIN switch and re-install the memory.





SECTION 2

4 Mobile Multi-Bay Units

Critical Points

- ◆ For the details on the units available for the PC, refer to page 35 for “Options”

IMPORTANT NOTE

When using a mobile multi-bay unit, pay attention to the following instruction to avoid failures:

- The built-in CD-ROM drive unit, the built-in DVD-ROM drive unit, the built-in CD-R/RW drive unit, and the built-in Superdisk drive unit are very delicate devices in which disks spin at high speeds. When you are accessing a disk, do not carry the PC nor give it any shock or vibration. It may cause the drive unit and/or the data to be damaged.
- Do not store the units in a place where it becomes extremely hot or cold or the environmental temperature drastically changes.
- Do not expose the units in the direct sunlight and keep them away from a heater.
- Do not store the units in a place where they undergo shocks and vibrations.
- Do not use the units in a highly humid and/or dusty place.
- Do not use the units leaving any liquid or metal objects inside. If a unit has a foreign matter inside, contact your dealer or Fujitsu Service Center.
- Wipe off stains with a dry, soft cloth or a soft cloth dampened with neutral detergent diluted by water. Avoid use of volatile chemicals such as benzine and thinner.
- Do not disassemble the units.
- Do not store or use the units near a magnet or a machine that generates a magnetic field.

Before Replacing Mobile Multi-bay Unit

Some operation systems may allow you to replace a mobile multi-bay unit while the PC power is on.

Critical Points

- ◆ Prior to removing the built-in PC card unit, remove the PC card from the PC card slot.
- ◆ Prior to removing the CCD camera, exit from the applications that use the camera.
- ◆ Prior to removing the additional built-in battery unit, ensure that the built-in battery has enough power. Otherwise connect the AC adapter in advance.

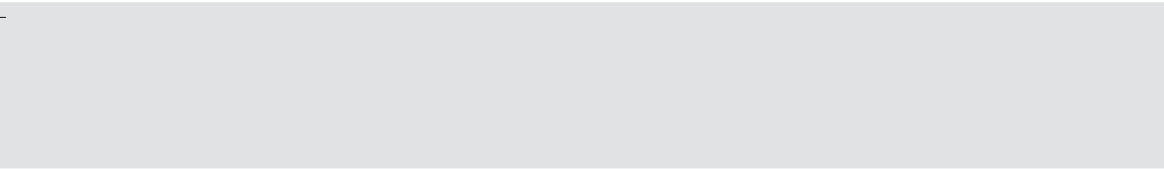

Windows Me and Windows 98

To replace a unit immediately after purchase, switch the PC power off in advance. Once you installed the attached Softex BayManager, you can replace a unit while the PC power is on.

Windows NT

To replace a unit immediately after purchase, switch the PC power off in advance.



❑ Replacing Mobile Multi-bay Unit

This section describes how to replace a mobile multi-bay unit.

1 Remove the unit.

Raise the mobile multi-bay unit removal lever (1) and remove the multi-bay unit (2).

2 Install the new unit.

Firmly insert it with the connector side facing inward.

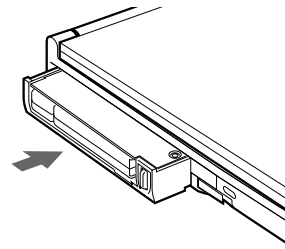
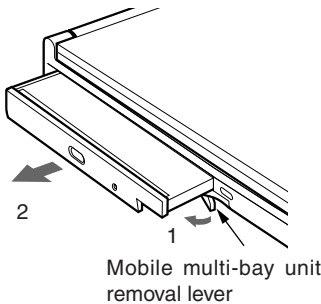

IMPORTANT NOTE

- Always set a mobile multi-bay unit when using the PC. The PC may be damaged if no multi-bay unit is set in place.
- Raise the mobile multi-bay unit removal lever only when removing the multi-bay unit. Otherwise the lock may be released. Should it be raised accidentally, switch the PC power off, remove the unit, and install it again.

Critical Points

- ◆ To use the built-in Superdisk drive unit, change the BIOS setup settings.
 - “Floppy disk A” in the “Main” menu: Not used
 - “Floppy disk controller” in “Other built-in device settings” in the “Detail” menu: Not used



SECTION 2

5 CD-ROM Drive

IMPORTANT NOTE

Be careful for the following points in the use of a CD to avoid failure.

- Do not use a ball-point pen or a pencil on label surface (printed surface) to write letters. And do not attach a label on it.
- Do not touch or damage the data surface.
- Do not bend or put a heavy object on a CD.
- Wipe dew drop and dirt on a CD with a dry soft cloth from the center to the outer side (Do not use cleaner or other chemicals).
- Be careful not to splash coffee and other liquid.
- Do not store in a hot or cold place.
- Do not store in a humid or dusty place.

Setting/Removing CD

This section describes how to set/remove a CD.

1 Press the EJECT button.

The tray pops out a little.

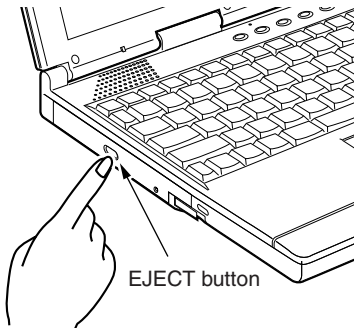

2 Manually draw the tray gently (1) and place a CD on it (2).

While retaining the tray by one hand, press the CD down with the label side facing upward until you hear a click from the lug in the center of the tray.

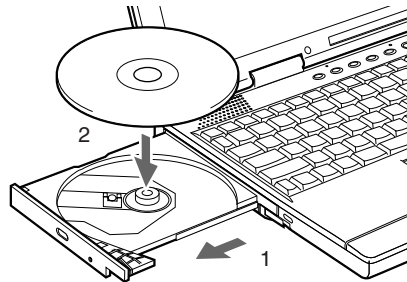

3. Gently push the tray inward.

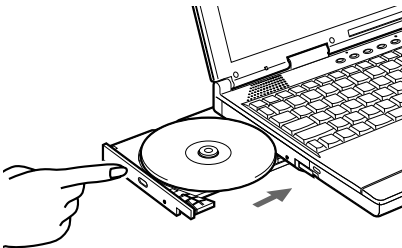



IMPORTANT NOTE

- To place a CD on the tray, fit the CD hole to the lug in the center of the tray and press it firmly until you hear a click. Lose insertion of the CD can cause damage to the internal assemble of the drive.

Critical Points

- ◆ Because the built-in CD drive unit of the PC is electronically locked, setting/removing a CD is possible only when the PC is running.
- ◆ The tray may not be completely shut if the PC power is off. In this case, switch the PC power on and try it again.
- ◆ To remove a CD take the same procedures as those for setting.
- ◆ Should the tray do not eject out by any reason, double click on the “My computer” icon, right click on the “CD” icon in the “My computer” dialog box, then click on the “Eject” button.

If this does not solve the problem, then use a ball-point pen, etc., poke in the hole in the front surface of the CD drive unit and at the right side of the eject button, and draw the tray out.

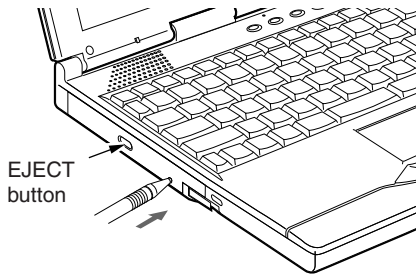

SECTION 2

6 Connector Box

The connector box is described here.

IMPORTANT NOTE

- The connector box can be installed/removed regardless of the condition of the PC. If the FDD unit is connected to the FDD unit connector of the connector box, however, install/remove the connector box after switching the PC power off.
- Certain peripheral devices connected to the connector box may operate unstably if the connector box is installed/removed while the PC power is on. If this happens, switch the PC power off prior to installing/removing the connector box.

Installing the connector box

This section describes how to install the connector box.

If any peripheral device is connected to the PC rear side, remove it beforehand.

CAUTION

Injury



- Be careful not to catch your fingers in the space between the PC and the connector box when installing it. It may cause an injury.

1 Install the connector box to the PC bottom side.

Fitting the connectors on the PC and the connector box, lower the PC horizontally (1), lightly press the parts shown below (2), and firmly set the connector box.

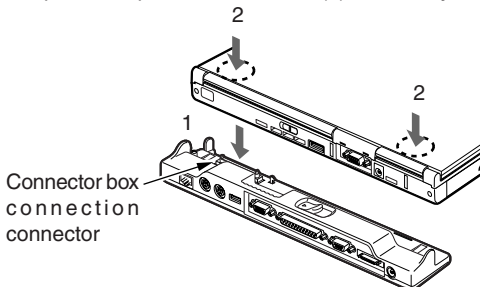

IMPORTANT NOTE

- To install a peripheral device to or remove it from the connector box, be sure to switch the PC power off and disconnect the AC adapter in advance.
- Do not carry the PC with the connection box installed. The connectors on the PC and/or the connector box may be damaged.



Removing the connector box

This section describes how to remove the connector box.

- 1 If any peripheral device is connected to the connector box, switch the power off.**
- 2 Release the connector box lock.**
Release the lock by sliding the connector box removal lever.
- 3 Remove the connector box.**
While keeping the removal lever in the unlocking position (1), lift the side having the connector first (2) then the other side of the PC (3) to remove the connector box.

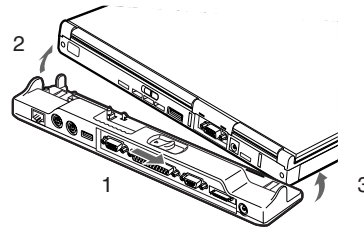
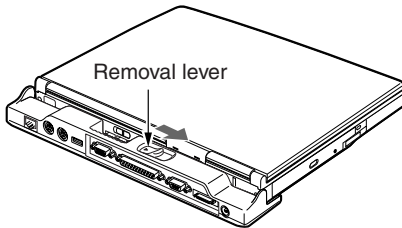

SECTION 2

7 Using Internal Data / Fax Modem

Connection

Depending on the model, the PC has an internal data fax modem that corresponds to V.90, which realizes comfortable and error-free communications in accordance with MNP Class 4/5 and ITU-T V.42/V.42bis.

⚠ WARNING

ELECTRIC SHOCK



- To connect a modular cable, be sure to switch the PC power off and disconnect the AC adapter beforehand. Otherwise you may undergo an electric shock.

ELECTRIC SHOCK



- If lightning occurs in the neighborhood, switch the PC power off and disconnect the AC adapter and the modular cable. Continuing use may cause the PC to be damaged and a fire to break out.

⚠ CAUTION

ELECTRIC SHOCK



- Do not put your fingers in the modular connector. It may cause an electric shock.

1. Switch the PC power off and disconnect the AC adapter.
2. Connect the modular connector on the PC and the telephone line via a modular cable.

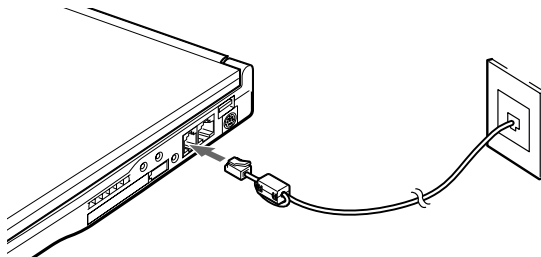

Critical Points

- ◆ To remove the plug from the modular connector, draw it while holding down the lug. Otherwise damages may occur.
- ◆ It is recommended to use the AC adapter when using the modem because the power consumption increases.

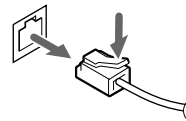



Critical Points

- ◆ When you connect a data / fax modem for the modem model PC, attach a core onto a modular cable to reduce unnecessary radio to reduce unnecessary electromagnetic wave. And insert the plug with the core to the PC unit.

1 Round a cable once immediately after the modular cable plug.

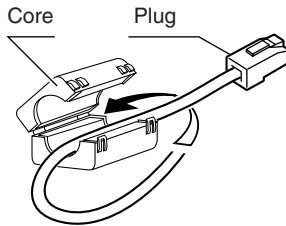

2 Close the core.

Make sure not to pinch the cable when you close the core.

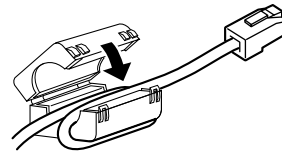

SECTION 2

SECTION 2

8 Using Internal LAN

Connection

Some types of this PC series have a built-in LAN device to enable high-speed connection to LAN system on IEEE802.3 standard through 100BASE-TX. And the LAN connection through conventional 10BASE-T is also available.

⚠ WARNING

ELECTRIC SHOCK



- Make sure to turn off the power of the PC unit and remove the AC adapter when you connect a LAN Cable, or you may experience electric shock.

ELECTRIC SHOCK



- When it thunders in the vicinity, turn off the power of the PC unit and remove the AC adapter and a LAN cable, or the thunder may destroy the PC and cause fire.

⚠ CAUTION

ELECTRIC SHOCK



- Do not insert your finger into LAN connector, or you may experience electric shock.

- 1 Turn off the power of the PC unit and remove the AC adapter.
- 2 Connect the LAN connector on the PC unit and the network with a LAN cable.

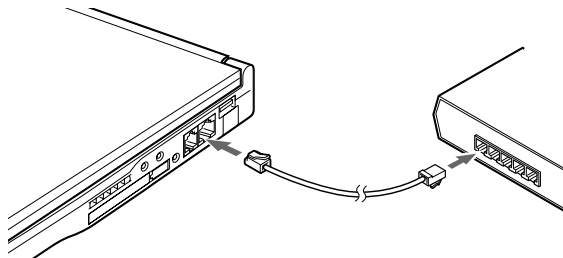

Critical Points

- ◆ To remove the plug from the LAN connector, draw it while holding down the lug. Otherwise damages may occur.
- ◆ It is recommended to use the AC adapter when using a LAN because the power consumption increases.
- ◆ If the PC has the connector box installed, The LAN connector on the PC cannot be used. Use that on the connector box.

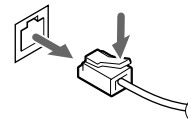

SECTION 2

9 Mouse

Connecting PS/2 Mouse

You can connect a PS/2 mouse to the mouse connector on the connector box.

1 Switch the PC power off or suspend the PC.

2 Install the connector box.

3 Connect the mouse.

Connect the mouse to the mouse connector on the connector box. For this, the arrow inscribed on the connector must face upward.

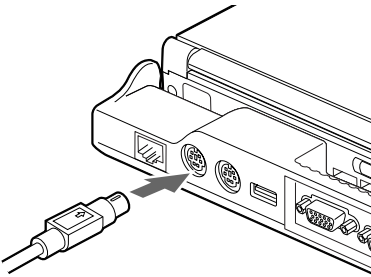

Critical Points

- ◆ The flat point is automatically disabled if you connect a PS/2 mouse.
- ◆ Use “Keyboard/mouse setting” of the BIOS setup to make both the flat point and the mouse available at the same time and to set the hot plug function.



Connecting USB Mouse

(Supported only by Windows 2000, Windows Me and Windows 98)

You can connect a separately available USB mouse to the USB connector.

1 Connect the mouse to the USB connector on the PC.

Paying attention to the shapes of the plug and the connector, insert the plug in the right direction.

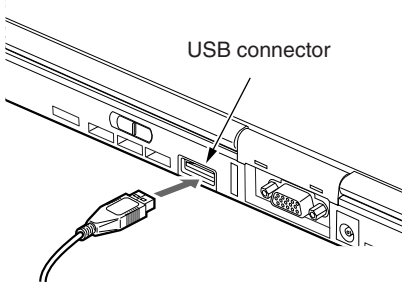

Critical Points

- ◆ The mouse can be connected/disconnected while the PC power is on. For connection, insert the plug in the right direction.
- ◆ Connecting the USB mouse does not disable the flat point. To disable it, refer to “Disabling Flat Point”.
- ◆ The USB mouse is disabled in the MS-DOS mode.

Disabling Flat Point

When you connect a USB mouse to this PC, both of the flat point and the USB mouse are enabled. If you want to disable the flat point when you connect a USB mouse, make the following settings:

- 1 Set “Internal pointing device” item in BIOS setup to “Manual”.
- 2 When Windows 2000 or Windows 98 or Windows Me starts up, push down the [F4] key while pressing down the [Fn] key.
The flat point is enabled or disabled every time when you push down the key.

IMPORTANT NOTE

Make sure to connect a mouse when you disable the flat point.

Critical Points

- ◆ Even though you disabled the flat point by pushing down the [F4] key while pressing down the [Fn] key, the flat point is enabled after restart or resume operation of the PC.
- ◆ If you set “Internal pointing device” item in BIOS set up to “Always disabled”, the flat point is always disabled.



How to Use Mouse

Put your hand on a mouse so that your fingers cover the left and right button of the mouse. And move the mouse as if you slide it on a desk and other flat place. The arrow (called as a “mouse pointer”) on the display moves following the mouse movement. Move the mouse while looking at the display.

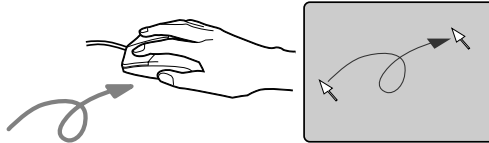

Button Operation

• Click

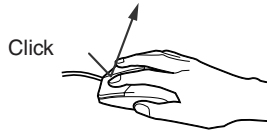

To push down the left button of the mouse once, and pushing down the right button is called “right-click”.

• Double-click

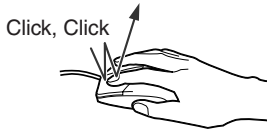

To Push down the left button of the mouse twice consecutively.

• Point

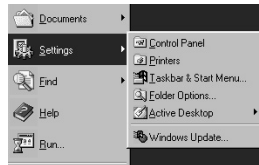

To set the mouse pointer over a menu and other components on the screen. When you set the mouse pointer on a menu and if the menu has sub-menu under it (indicated with > mark on the right end of the menu), the sub-menu appears.

• Drag

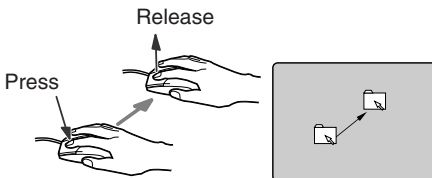

To move the mouse with holding down the left button of the mouse and release the button at your favorite place.

Critical Points

- ◆ The button operations mentioned here are applicable when “For right-handed person” in “Mouse property” dialog box.





SECTION 2

10 Connecting Numeric Keypad / Keyboard / Mouse

The extended keyboard connector on the connector box can be used to connect a PS/2 numeric keypad, etc. This section describes connection of a numeric keypad.

1 Switch the PC power off or suspend the PC.

2 Install the connector box.

3 Connect the numeric keypad.

Connect the numeric keypad to the extended keyboard connector on the connector box. Make sure that the arrow mark on the connector is on the top.

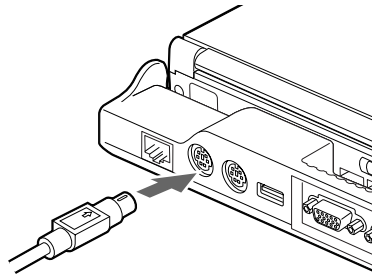

Critical Points

◆ The numeric keypad is usable only when the PC is in the numeric key mode.

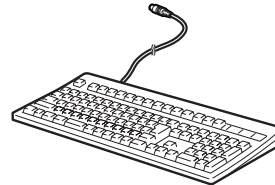
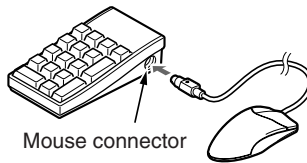

◆ The mouse connector on the numeric keypad can be used to connect a mouse.

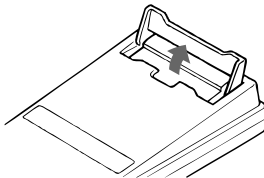

◆ Adjust the slanting angle of the numeric keypad using the tilt foot on the bottom surface of the keypad.

◆ The extended keyboard connector can also be connected with a 101 keyboard.





SECTION 2

11 Printer

This section describes connection of a printer to the parallel connector on the connector box. With a printer, you can print the documents and images that are generated on the PC.

Critical Points

- ◆ If the printer is one corresponding to USB connection, the USB connector can also be used for connection.

Connecting Printer

! WARNING

ELECTRIC SHOCK



- To connect/remove a printer, be sure to switch the PC power off and disconnect the AC adapter beforehand. Otherwise you may undergo an electric shock.

! CAUTION

FAILURE



- When connecting cables, read this manual well to avoid misconnection. If the PC is used with a wrong connection, the PC and/or the printer may be damaged.

- 1 Switch the PC power off and disconnect the AC adapter.
- 2 Install the connector box.
- 3 Connect the printer cable to the parallel connector on the connector box.
When viewed from the front, the connectors are in a trapezium shape. Study the shapes of the connectors and firmly insert the cable connector (1), then fix it, tightening the left and right screws on it (2).

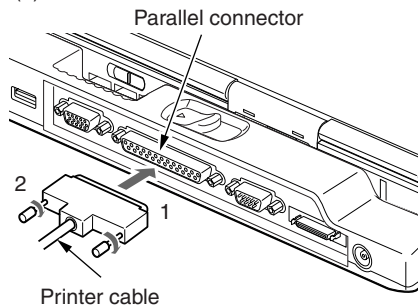



- 4 Connect the printer cable and the power cable to the printer.**
Refer to the printer manual for the details on connection.
Some printers may already have their power cables fixed on them.
- 5 Insert the printer power cable plug to a receptacle and switch the printer power on.**
- 6 Connect the AC adapter to the PC and switch the PC power on.**
- 7 If the printer is connected for the first time, install the driver.**
Read the printer manual to install the driver.
Floppy disk(s) or CD(s) may be used for driver installation.

Critical Points

- ◆ Printer connection needs a printer cable. Some printer packages may not include a printer cable.
- ◆ In addition, the printer cable that is attached to the printer may not be used due to a different connector shape. If this is the case, obtain a separately available cable that can be connected to the PC.
- ◆ The printer connection procedures differ depending on your printer. Refer to the printer manual for the details.

12 Connecting External Display

Connecting an external display

You can connect a CRT display and other external display to this PC. Here is the explanation on how to connect a CRT display to the auxiliary display connector on the back of the PC unit.

⚠ WARNING

ELECTRIC SHOCK



- To connect/remove an external display, be sure to switch the PC power off and disconnect the AC adapter beforehand. Otherwise you may undergo an electric shock.

⚠ CAUTION

FAILURE



- When connecting cables, read the instruction carefully to avoid misconnection. If the PC is used with a wrong connection, the PC and/or the external display may be damaged.

- 1 **Switch the PC power off and disconnect the AC adapter.**
- 2 **Connect the display cable to the external display connector on the rear side of the PC.** When viewed from the front, the connectors are in a trapezium shape. Study the shapes of the connectors and firmly insert the cable connector (1), then fix it, tightening the left and right screws on it (2).

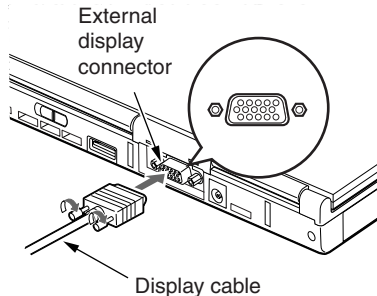

Critical Points

- ◆ You can also use the display connector on the connector box for connection of an external display.
- ◆ Use the external display connector on the PC to obtain clearer images.
- ◆ The top and bottom sides of the trapezium shape of the external display connectors on the PC are opposite from those on the connector box.



- 3 **Connect the display cable to the CRT display.**
Refer to the CRT display manual for the details on connection.
- 4 **Connect the CRT display power cable and switch the display power on.**
- 5 **Connect the AC adapter to the PC and switch the PC power on.**

Critical Points

If you turn the power on after connecting an external display, you may experience the following phenomena:

- ◆ The same screen image is displayed on both of the liquid crystal display on the PC unit and the external display.
 - ◆ “Add New Hardware Wizard” dialog box appears.
 - ◆ In such cases, follow the instruction on the display to install the driver for the external display.
- 6 **Select the display to use.**
When you push down the [F10] key while pressing down the [Fn] key, you can select the display to use in the order of LCD to CRT to the simultaneous display to LCD. And you can select the display also from “Display Property” in the operating system.

SECTION 2

13 Connecting a TV Set (depend on model)

Connecting a TV Set for Home Use

(Supported Only By Windows 2000 and Windows 98)

Depending on the model, the PC is equipped with an S-Video output terminal, to which you can connect a TV set used at your home. This section describes connection of a TV set for home use.

WARNING

ELECTRIC SHOCK



- To connect/remove a TV set, be sure to switch the PC power off and disconnect the AC adapter beforehand. Also switch the TV power off and unplug the TV set. Otherwise you may undergo an electric shock.

CAUTION

FAILURE



- When connecting cables, read the instruction carefully to avoid misconnection. If the PC is used with a wrong connection, the PC and/or the TV set may be damaged.

- 1 **Switch the PC power off and disconnect the AC adapter.**
- 2 **Switch the TV power off and unplug the TV set.**
- 3 **Connect a commercial A/V cable to the S-Video output terminal on the right side of the PC.**
Firmly connect the commercial A/V cable to the S-Video output terminal on the PC.

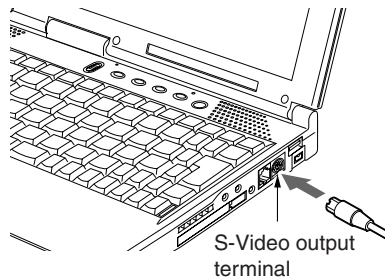

- 4 **Connect the A/V cable to the TV set.**
Refer to the TV set manual for this connection.
- 5 **Connect the AC adapter to the PC and switch the PC power on.**
- 6 **Plug the TV set and switch the power on.**
- 7 **Change the screen display.**

SECTION 2

14 Using Digital Video Camera (depend on model)

Depending on the model, the PC is equipped with an IEEE1394 (DV) terminal, where you can connect a digital video camera.

With a digital video camera connected, the PC can display the photographed images.

IMPORTANT NOTE

- Use a DV cable with 4-pin connectors for connection between the digital video camera and the PC. Those having 6-pin connectors cannot be used.

Connecting Digital Video Camera

This section describes connection of a digital video camera to the IEEE1394 (DV) terminal on the right side of the PC.

⚠ WARNING

ELECTRIC SHOCK



- To connect/remove a digital video camera, be sure to switch the PC power off and disconnect the AC adapter beforehand. Otherwise you may undergo an electric shock.

⚠ CAUTION

FAILURE



- When connecting cables, read this instruction to avoid misconnection. If the PC is used with a wrong connection, the PC and/or the digital video camera may be damaged.

- 1 **Switch the PC power off and disconnect the AC adapter.**
- 2 **Connect a commercial DV cable to the IEEE1394 (DV) terminal on the right side of the PC.** Firmly insert the commercial DV cable to the IEEE1394 (DV) terminal on the PC.

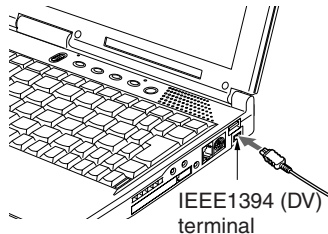

- 3 **Connect the DV cable to the digital video camera.**
Refer to the digital video camera manual for this connection.
- 4 **Connect the AC adapter to the PC and switch the PC power on.**
- 5 **Connect the power cable to the digital video camera and switch the video camera power on.**
The driver of the digital video camera is automatically installed when the PC is booted.



SECTION

3

SECTION 3

This section explains what to do when trouble occurs with this computer and when messages are displayed. Read this section as the necessity arises.

SECTION 3

1 When This Happens

When you are having trouble with this computer, there is something you think is strange, or there is something you want to do, but do not know how. This section is divided into related items.

● The power does not come on.

Checkpoint	Cause and Solution
Is the AC adaptor connected?	When using this computer for the first time after purchase, the battery is not yet charged, so you must connect the AC adaptor and turn on the main switch.
Is the main switch turned on?	If the main switch is not turned on, the power will not come on even if the SUS/RES button is pressed.
Is the battery charged?	If a beep is heard when the main switch is turned on, then the battery is running low (LOW BATTERY). Connect the AC adaptor.
Has the computer been left unused for a long time?	When using the computer for the first time after leaving it unused for a long time, connect the AC adaptor and switch on the main switch to switch on the power.

● Nothing displayed on the LCD panel

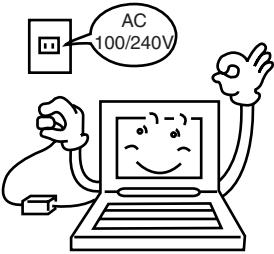
Checkpoint	Cause and Solution
Is  displayed on the LCD panel? 	<ul style="list-style-type: none"> • Displayed Adjust the brightness and darkness with the brightness and contrast controls. • Flashing or not displayed Press the SUS/RES button to put the computer into operating mode. Check if the battery is charged. If it is not charged, connect the AC adaptor and charge it. If you are already using this computer with the AC adaptor connected, check that it is correctly plugged into the power socket and into the computer.
Is anything displayed on the status indicator LCD?	Connect the AC adaptor and switch on the main switch.



Checkpoint	Cause and Solution
Have you been pressing any of the keys?	On this computer, if the power management functions are set and no key is pressed for a certain period of time, the CPU stops and the LCD panel backlight goes out. (In this state, pressing any key lights up the backlight again.) If the computer stops too frequently, change the BIOS setup settings.
Is it set to output to the CRT?	Switch over to the LCD display with the [Fn] + [F10] keys.

● **LCD panel hard to read**

Checkpoint	Cause and Solution
Is the control adjusted?	Adjust the brightness with the brightness and contrast controls.

● **Battery is not charged**

Checkpoint	Cause and Solution
Is the AC adaptor connected?	Check that the AC adaptor is correctly plugged into the power socket and into the computer.
Is the battery overheated (The → on the LCD display flashes.)?	If the ambient temperature is high and the battery temperature becomes too high during use, the battery protection function may be triggered to stop the charging.
Is the computer too cold (The → on the LCD display flashes.)?	If the battery temperature falls too low, the battery protection function may be triggered to stop the charging.
Was the charging stopped midway?	If you use the computer and disconnect the AC adaptor between the start of charging and the time the → LCD turns off, then the battery will not become fully charged. Once you start charging do not remove the AC adaptor until the → LCD turns off.

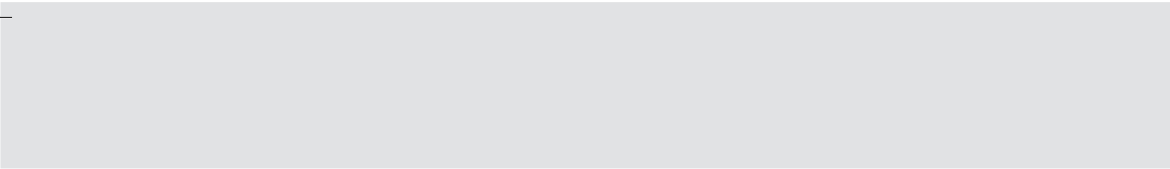

● **The remaining battery charge indicator does not stop flashing.**

Checkpoint	Cause and Solution
Is the battery connected correctly?	Check that the battery is connected correctly. If it is connected correctly, there is an abnormality in the battery pack, so replace the battery pack.
Is the battery low?	Attach the AC adaptor and charge the battery.

● **Floppy disk can not be used.**

Checkpoint	Cause and Solution
If the floppy disk loaded into the floppy disk drive correctly?	Insert the floppy disk with its label facing up, into the drive shutter and keep inserting firmly until you hear a clicking sound.
Is the floppy disk formatted?	New floppy disks can not be used until they are formatted (initialized). Format the floppy disk.
Is Diskette A set to Not Installed in the BIOS setup?	Check the Diskette A item in the BIOS setup Main menu.
Is Diskette access set to Supervisor only in the BIOS setup?	Check the Diskette access item in the BIOS setup Security menu.
Is the floppy disk write inhibited?	Set the write protect tab on the floppy disk to the write enable position.
Does it work with a different floppy disk?	If it works with a different floppy disk then the problem floppy disk may be damaged.





● **No sound or minimal sound from speaker**

Checkpoint	Cause and Solution
Is the volume control correctly adjusted?	Turn the volume control for the correct volume. If this does not change the volume, double click the task bar sound indicator and adjust the volume. Check also whether the sound driver is installed correctly.

● **Can not record from Mic or Line In jack**

Checkpoint	Cause and Solution
Is the mic correctly adjusted?	Turn the volume control to obtain the correct volume. If the line jack is connected to the sound source, then check that connection. If this still does not solve the problem, then double click the task bar sound indicator and adjust the volume.

● **LCD panel does not close.**

Checkpoint	Cause and Solution
Is something caught in the LCD display panel?	Forcing the LCD display panel closed can damage it. Check for something caught in the LCD display panel. Also, a metal object such as a paper clip can cause a breakdown if it gets caught in between the keys.

● **The power management function is not executed.**

Checkpoint	Cause and Solution
Is Power Savings set to off in the BIOS setup?	Reset the BIOS setup.
Are you executing a program that rewrites the screen?	If you are executing a program that rewrites the screen even when no key is pressed, for example a clock display or screen save, the power management function is not executed.

● **Message displayed on screen**

See the message list.

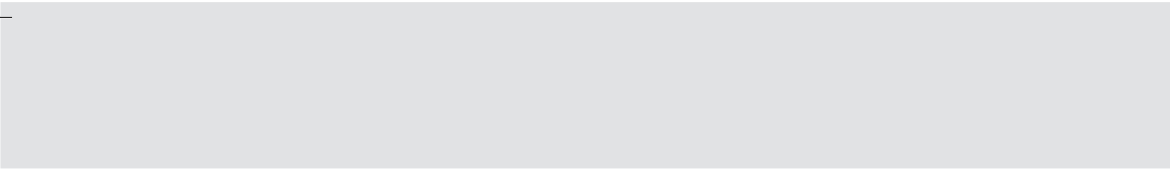

● **Data cannot be read from the CD-ROM drive.**

Checkpoint	Cause and Solution
Is the CD-ROM correctly set?	Set the CD-ROM correctly with its label facing upwards.
Is there any dirt, condensation or water on the CD-ROM?	Wipe it from the center outwards with a dry, soft cloth.
Is the CD-ROM scratched or extremely warped?	Replace the CD-ROM.
Are you using a non-standard CD-ROM?	Use a CD-ROM which conforms to the standards.

● **The CD cannot be ejected from the CD-ROM.**

Checkpoint	Cause and Solution
Is it in operating mode?	<p>The CD can only be ejected when the personal computer main unit is in operating mode because its CD-ROM drive has an electronic lock. Check that the personal computer main unit is in operating mode and press the EJECT button. If for some reason the CD tray does not come out even when you press the EJECT button, insert a clip or something into the hole to the right of the EJECT button and pull the tray out.</p> <p>If the tray doesn't still come out, click the CD-ROM icon in the "My Computer" window with the right button of the mouse and then click "EJECT".</p>



2 Care and Maintenance

If you use your Fujitsu LifeBook notebook carefully, you will increase its life and reliability. This section provides some tips for looking after the notebook and its devices.

Caution:

Electrical equipment may be hazardous if misused. Operations of this product or similar products, must always be supervised by an adult. Do not allow children access to the interior of any electrical products and do not permit them to handle any cables.

LIFEBOOK NOTEBOOK

Caring for your LifeBook Notebook

- Your Lifebook notebook is a durable but sensitive electronic device. Treat it with care.
- Make a habit of transporting it in a suitable carrying case.
- Do not attempt to service the computer yourself. Always follow installation instructions closely.
- Keep it away from food and beverages.
- If you accidentally spill liquid on your notebook:
 1. Turn it off.
 2. Position it so that the liquid can run out.
 3. Let it dry out for 24 hours, or longer if needed.
 4. If your notebook will not boot after it has dried out, call your support representative.
- Do not use your LifeBook notebook in a wet environment (near a bathtub, swimming pool).
- Always use the AC adapter and batteries that are approved for your notebook.
- Avoid exposure to sand, dust and other environmental hazards.
- Do not expose your LifeBook notebook to direct sunlight for long periods of time as temperatures above 140°F (60°C) may damage your notebook.
- Keep the covers closed on the connectors and slots when they are not in use.
- Do not put heavy or sharp objects on the computer.
- If you are carrying your LifeBook notebook in a briefcase, or any other carrying case, make sure that there are no objects in the case pressing on the lid.
- Do not drop your LifeBook notebook.
- Do not touch the screen with any sharp objects.

Cleaning your LifeBook Notebook

- Always disconnect the power plug. (Pull the plug, not the cord.)
- Clean your LifeBook notebook with a damp, lint-free cloth. Do not use abrasives or solvents.
- Use a soft cloth to remove dust from the screen. Never use glass cleaners.



Storing your LifeBook Notebook

- If storing your notebook for a month or longer, turn your LifeBook notebook off and remove all Lithium Ion batteries.
- Store your LifeBook notebook and batteries separately. If you store your notebook with a battery installed, the battery will discharge, and battery life will be reduced. In addition, a faulty battery might damage your notebook.
- Store your LifeBook notebook in a cool, dry location. Temperatures should remain between -25°C (13°F) and 60°C (140°F).

Travelling with your LifeBook Notebook

- Do not transport your LifeBook notebook while it is turned on.
- Do not check your LifeBook notebook as baggage. Carry it with you.
- Always bring your System Recovery CD that came with your LifeBook notebook when you travel. If you experience system software problems while travelling you may need it to correct any problems.
- Never put your LifeBook notebook through a metal detector. Have your notebook hand-inspected by security personnel. You can, however, put your LifeBook notebook through a properly tuned X-ray machine. To avoid problems, place your notebook close to the entrance of the machine and remove it as soon as possible or have your notebook hand-inspected by security personnel. Security officials may require you to turn your notebook On. Make sure you have a charged battery on hand.

Outlet type	Location
	United States, Canada, parts of Latin America, Japan, Korea, the Philippines, Taiwan
	Russia and the Commonwealth of Independent States (CIS), most of Europe, parts of Latin America, the Middle East, parts of Africa, Hong Kong, India, most of South Asia
	Mexico, United Kingdom, Ireland, Malaysia, Singapore, parts of Africa
	China, Australia, New Zealand





- When travelling with the hard drive removed, wrap the drive in a non-conducting materials (cloth or paper). If you have the drive checked by hand, be ready to install the drive if needed. Never put your hard drive through a metal detector. Have your hard drive hand-inspected by security personnel. You can however, put your hard drive through a properly tuned X-ray machine.
- Take the necessary plug adapters if you're travelling overseas. Check the following diagram to determine which plug adapter you'll need or ask your travel agent.

BATTERIES

Caring for your Batteries

- Always handle batteries carefully.
- Do not short-circuit the battery terminals (that is, do not touch both terminals with a metal object). Do not carry loose batteries in a pocket or purse where they may mix with coins, keys, or other metal objects. Doing so may cause an explosion or fire.
- Do not drop, puncture, disassemble, mutilate or incinerate the battery.
- Recharge batteries only as described in this manual and only in ventilated areas.
- Do not leave batteries in hot locations for more than a day or two. Intense heat can shorten battery life.
- Do not leave a battery in storage for longer than 6 months without recharging it.

Increasing Battery Life

- Power your LifeBook notebook through the AC or optional auto/airline adapter whenever possible.
- If your LifeBook notebook is running on battery power all day, connect it to the AC adapter overnight to recharge the battery.
- Keep brightness to the lowest level comfortable.
- Set the power management for maximum battery life.
- Put your LifeBook notebook in Suspend mode when it is turned on and you are not actually using it.
- Limit your DVD/CD-RW/CD-ROM access.
- Disable the Windows CD automatic insertion function.
- Always use fully charged batteries.
- Eject PCMCIA cards when not in use.

FLOPPY DISKS AND DRIVES

Caring for your Floppy Disks

- Avoid using the floppy disks in damp and dusty locations.
- Never store a floppy disk near a magnet or magnetic field.
- Do not use a pencil or an eraser on a disk or disk label.
- Avoid storing the floppy disks in extremely hot or cold locations, or in locations subject to severe temperature changes. Store at temperatures between 50°F (10°C) and 125°F (52°C)
- Do not touch the exposed part of the disk behind the metal shutter.



Caring for your Floppy Disk Drive

- To clean, wipe the floppy disk drive clean with a dry soft cloth, or with a soft cloth dampened with water or a solution of neutral detergent. Never use benzene, paint thinner or other volatile material.
- Avoid storing the floppy disk drive in extremely hot or cold locations, or in locations subject to severe temperature changes. Store at temperatures between 50°F (10°C) and 125°F (52°C)
- Keep the floppy disk drive out of direct sunlight and away from heating equipment.
- Avoid storing the floppy disk drive in locations subject to shock and vibration.
- Never use the floppy disk drive with any liquid, metal, or other foreign matter inside the floppy disk drive or disk.
- Never disassemble or dismantle your floppy disk drive.

DVD/CD-RW/CDs

Caring for your DVD/CD-RW/CDs

- DVD/CD-RW/CDs are precision devices and will function reliably if given reasonable care.
- Always store your DVD/CD-RW/CDs in its case when it is not in use.
- Always handle DVD/CD-RW/CDs by the edges and avoid touching the surface.
- Avoid storing any DVD/CD-RW/CDs in extreme temperatures.
- Do not bend DVD/CD-RW/CDs or set heavy objects on them.
- Do not spill liquids on DVD/CD-RW/CDs.
- Do not scratch DVD/CD-RW/CDs.
- Do not put a label on DVD/CD-RW/CDs.
- Do not get dust on DVD/CD-RW/CDs.
- Never write on the label surface with a ballpoint pen or pencil. Always use a felt pen.
- If a DVD/CD-RW/CD is subjected to a sudden change in temperature, cold to warm condensation may form on the surface. Wipe the moisture off with a clean, soft, lint free cloth and let it dry at room temperature, DO NOT use a hair dryer or heater to dry DVD/CD-RW/CDs.
- If a DVD/CD-RW/CD is dirty, use only a DVD/CD-RW/CD cleaner or wipe it with a clean, soft, lint free cloth starting from the inner edge and wiping to the outer edge.



Caring for your DVD/CD-RW/CD-ROM Drive

Your DVD/CD-RW/CD-ROM drive is durable but you must treat it with care. Please pay attention to the following points:

- The drive rotates the compact disk at a very high speed. Do not carry it around or subject it to shock or vibration with the power on.
- Avoid using or storing the drive where it will be exposed to extreme temperatures.
- Avoid using or storing the drive where it is damp or dusty.
- Avoid using or storing the drive near magnets or devices that generate strong magnetic fields.
- Avoid using or storing the drive where it will be subjected to shock or vibration.
- Do not disassemble or dismantle the DVD/CD-RW/D-ROM drive.

PC CARDS

Caring for your PC Cards

PC Cards are durable, but you must treat them with care. The documentation supplied with your PC Card will provide specific information, but you should pay attention to the following points:

- To keep out dust and dirt, store PC Cards in their protective sleeves when they are not installed in your notebook.
- Avoid prolonged exposure to direct sunlight or excessive heat.
- Keep the cards dry.
- Do not flex or bend the cards, and do not place heavy objects on top of them.
- Do not force cards into the slot.
- Avoid dropping cards, or subjecting them to excessive vibration.



SECTION 3

3 Glossary

AC Adapter

A device which converts the AC voltage from a wall outlet to the DC voltage needed to power your notebook.

Active-Matrix Display

A type of technology for making flat-panel displays which has a transistor or similar device for every pixel on the screen.

APM

Advanced Power Management.

Auto/Airline Adapter

A device which converts the DC voltage from an automobile cigarette lighter or aircraft DC power outlet to the DC voltage needed to power your notebook.

BIOS

Basic Input-Output System. A program and set of default parameters stored in ROM which tests and operates your notebook when you turn it on until it loads your installed operating system from disk. Information from the BIOS is transferred to the installed operating system to provide it with information on the configuration and status of the hardware.

Bit

An abbreviation for binary digit. A single piece of information which is either a one (1) or a zero (0).

bps

An abbreviation for bits per second. Used to describe data transfer rates.

Boot

To start-up a computer and load its operating system from disk, ROM or other storage media into RAM.

Bus

An electrical circuit which passes data between the CPU and the sub-assemblies inside your notebook.

Byte

8 bits of parallel binary information.

Cache Memory

A block of memory built into the micro-processor which is much faster to access than your system RAM and used in specially structured ways to make your overall data handling time faster.

CardBus

A faster, 32-bit version of the PC Card interface which offers performance similar to the 32-bit PCI architecture.

CD-ROM

Compact disc read only memory. This is a form of digital data storage which is read optically with a laser rather than a magnetic head. A typical CD-ROM can contain about 600MB of data and is not subject to be crashing into the surface and destroying the data when there is a failure nor to wear from reading.

**CMOS RAM**

Complementary metal oxide semiconductor random access memory. This is a technology for manufacturing random access memory which requires very low level power to operate.

COMM Port

Abbreviation for communication port. This is your serial interface connection.

Command

An instruction which you give your operating system. Example: run a particular application or format a floppy disk.

Configuration

The combination of hardware and software that make up your system and how it is allocated for use.

CRT

Cathode Ray Tube. A display device which uses a beam of electronic particles striking a luminescent screen. It produces a visual image by varying the position and intensity of the beam.

Data

The information a system stores and processes.

DC

Direct current. A voltage or current that does not fluctuate periodically with time.

Default Value

A pre programmed value to be used if you fail to set your own.

DIMM

Dual-in-line memory module.

LAN

Local Area Network. An interconnection of computers and peripherals within a single limited geographic location which can pass programs and data amongst themselves.

LCD

Liquid Crystal Display. A type of display which makes images by controlling the orientation of crystals in a crystalline liquid.

Lithium ion Battery

A type of rechargeable battery which has a high power-time life for its size and is not subject to the memory effect as Nickel Cadmium batteries.

LPT Port

Line Printer Port. A way of referring to parallel interface ports because historically line printers were the first and latter the most common device connected to parallel ports.

MB

Megabyte.

**Megahertz**

1,000,000 cycles per second.

Memory

A repository for data and applications which is readily accessible to your notebook CPU.

MHz

Megahertz.

MIDI

Musical Instrument Digital Interface. A standard communication protocol for exchange of information between computers and sound producers such as synthesizers.

Modem

A contraction for MODulator-DEModulator. The equipment which connects a computer or other data terminal to a communication line.

Monaural

A system using one channel to process sound from all sources.

MPU-401

A standard for MIDI interfaces and connectors.

NTSC

National TV Standards Commission. The standard for TV broadcast and reception for the USA.

Operating System

A group of control programs that convert application commands, including driver programs, into the exact form required by a specific brand and model of microprocessor in order to produce the desired results from that particular equipment.

Parallel Port

A connection to another device through which data is transferred as a block of bits simultaneously with a wire for each bit in the block and with other wires only for control of the device not for transfer of data.

Partition

A block of space on a hard drive which is set aside and made to appear to the operating system as if it were a separate disk, and addressed by the operating system accordingly.

PCMCIA

PCMCIA is trademark of the Personal Computer Memory Card International Association. The Personal Computer Memory Card International Association is an organization that sets standards for add-in cards for personal computers.

Peripheral Device

A piece of equipment which performs a specific function associated with but not integral to a computer. Examples: a printer, a mode, a CD-ROM.

**Pitch (keyboard)**

The distance between the centers of the letter keys of a keyboard.

Pixel

The smallest element of a display, a dot of color on your display screen. The more pixels screen. The more pixels per area the clearer your image will appear.

POST

Power On Self Test. A program which part of the BIOS which checks the configuration and operating condition of your hardware whenever power is applied to your notebook. Status and error messages may be displayed before the operating system is loaded. If the self test detects failures that are so serious that operation can not continue, the operating system will not be loaded.

Disk

A spinning platter of magnetic data storage media. If the platter is very stiff it is a hard drive, if it is highly flexible it is a floppy disk, if it is a floppy disk in a hard housing with a shutter it is commonly called diskette.

Disk Drive

The hardware which spins the disk and has the heads and control circuitry for reading and writing the data on the disk.

Diskette

A floppy disk in a hard housing with a shutter.

DMA

Direct Memory Access. Special circuitry for memory to memory transfer of data which do not require CPU action.

DMI

Desktop Management Interface. A standard that provides PC management applications with a common method of locally or remotely querying and configuring PC computer systems hardware and software components, and peripherals.

DOS

Disk Operating System (MS-DOS is a Microsoft Disk Operating System).

Driver

A computer program which converts application and operating system commands to external devices into the exact form required by a specific brand and model of device in order to produce the desired results from that particular equipment.

ECP

Extended Capability Port. A set of standards for high speed data communication and interconnection between electronic devices.

**ESD**

Electro-Static Discharge. The sudden discharge of electricity from a static charge which has built-up slowly. Example: the shock you get from a doorknob on a dry day or the sparks you get from brushing hair on a dry day.

Extended Memory

All memory more than the 640KB recognized by MS-DOS as system memory.

FCC

Federal Communication Commission.

Floppy Disk

A spinning platter of magnetic data storage media which is highly flexible.

GB

Gigabyte.

Hard drive

A spinning platter of magnetic data storage media where the platter is very stiff.

Hexadecimal

A decimal notation for the value of a 4 bit binary number. (0-9, A, B, C, D, E, F) Example: 2F in hexadecimal = 00101111 = 47 in decimal.

I/O

Input/Output. Data entering and leaving your notebook in electronic form.

I/O Port

The connector and associated control circuits for data entering and leaving your notebook in electronic form.

IDE

Intelligent Drive Electronics. A type of control interface for a hard drive which is inside the hard drive unit.

Infrared

Light just beyond the red portion of the visible light spectrum which is invisible to humans.

IR

An abbreviation for infrared.

IrDA

Infrared Data Association. An organization which produces standards for communication using infrared as the carrier.

IRQ

Interrupt Request. An acronym for the hardware signal to the CPU that an external event has occurred which needs to be processed.

**KB**

Kilobyte.

Program

An integrated set of coded commands to your computers telling your hardware what to do and how and when to do it.

PS/2

An IBM series of personal computers which established a number of standards for connecting external devices such as keyboards and monitors.

RAM

Random Access Memory. A hardware component of your notebook that holds binary information (both program and data) as long as it has the proper power applied to it.

RAM Module

A printed circuit card with memory and associated circuitry which allows the user to add additional memory to the computer without special tools.

Reset

The act of reloading the operating system. A reset erases all information stored in RAM.

Restart

See Reset.

Resume

To proceed after interruption. In your notebook this refers to returning to active operation after having been in one of the suspension states.

ROM

Read Only Memory. A form of memory in which information is stored by physically altering the material. Data stored in this way can not be changed by your notebook and does not require power to maintain it.

SDRAM

Synchronous Dynamic Random Access Memory.

Serial Port

A connection to another device through which data is transferred one bit at a time on a single wire with any other wires only for control of the device not for transfer of data.

Shadow RAM

A technique of copying data or applications stored in ROM (Read Only Memory) into RAM (Random Access Memory) for access during actual operation. RAM is much faster to access than ROM, however ROM contents are not lost when power is removed. Shadowing allows permanently stored information to be rapidly accessed.



SMART

Self-Monitoring, Analysis and Reporting Technology (SMART) is an emerging technology that provides near-term failure predictions for hard drives. When SMART is enabled the hard drive monitors predetermined drive attributes that are susceptible to degradation over time. If a failure is likely to occur, SMART makes a status report available so that the LifeBook can prompt the user to back up the data on the drive. Naturally not all failures are predictable. SMART predictability is limited to those attributes which the drive can self-monitor. In those cases where SMART can give advance warning, a considerable amount of precious data can be saved.

SRAM

Static random access memory. A specific technology of making RAM which does not require periodic data refreshing.

Status Indicator

A display which reports the condition of some portion of your hardware. On your notebook this is an LCD screen just above the keyboard.

Stereo (audio)

A system using two channels to process sound from two different sources.

Stroke (keyboard)

The amount of travel of a key when it is pressed from resting to fully depressed.

Suspend

To make inoperative for a period of time. Your notebook uses various suspension states to reduce power consumption and prolong the charge of your battery.

SVGA

Super VGA.

S-Video

Super Video. A component video system for driving a TV or computer monitor.

System Clock

An oscillator of fixed precise frequency which synchronizes the operation of the system and is counted to provide time of day and date.

TFT

Thin Film Transistor - A technology for flat display panels which uses a thin film matrix of transistors to control each pixel of the display screen individually.

UL

Underwriters Laboratories - An independent organization that tests and certifies the electrical safety of devices.

VGA

Video Graphics Array. A video display standard originally introduced by IBM with the PS/2 series of personal computers.

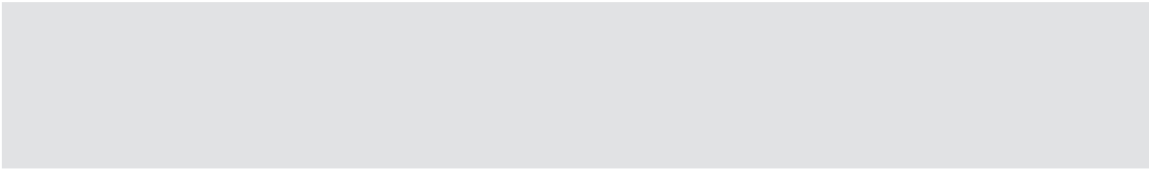

VRAM

Video Random Access Memory. A memory dedicated to video display data and control.

WFM

Wired for Management is Intel's broad-based initiative to reduce the total cost of ownership (TCO) of business computing without sacrificing power and flexibility.

Write Protect

Prevent alteration of the binary state of all bits in a storage media. Example: all information on a device such as a floppy diskette; a block of space in a storage media such as partition of a hard drive; a file or directory of floppy diskette or hard drive.

XGA

Extended VGA.

Zip Drive

A 100MB read/write removable media disk drive.

Zoomed Video

A PC Card port which allows notebook PCs to deliver full screen broadcast quality video through third party PC Cards, including TV tuners, video capture, and MPEG full-motion video.